

# EPOS4

## Communication Guide



epos.maxongroup.com

## TABLE OF CONTENTS

<b>1</b>	<b>ABOUT THIS DOCUMENT</b>	<b>3</b>
<b>2</b>	<b>USB &amp; RS232 COMMUNICATION</b>	<b>7</b>
	2.1 EPOS4 USB & RS232 Command Reference . . . . .	7
	2.2 Data Link Layer . . . . .	12
	2.3 Physical Layer . . . . .	20
<b>3</b>	<b>CAN COMMUNICATION</b>	<b>21</b>
	3.1 General Information . . . . .	21
	3.2 CANopen Basics . . . . .	23
	3.3 CANopen Application Layer . . . . .	25
	3.4 Identifier Allocation Scheme . . . . .	34
	3.5 Layer Setting Services (LSS) . . . . .	35
<b>4</b>	<b>ETHERCAT COMMUNICATION</b>	<b>41</b>
	4.1 Communication Specifications . . . . .	42
	4.2 EtherCAT State Machine (ESM) . . . . .	42
	4.3 Integration of ESI Files . . . . .	44
	4.4 Error Code Definition . . . . .	44
<b>5</b>	<b>GATEWAY COMMUNICATION (USB OR RS232 TO CAN)</b>	<b>45</b>
<b>6</b>	<b>COMMUNICATION ERROR CODE DEFINITION</b>	<b>47</b>
	<b>LIST OF FIGURES</b>	<b>49</b>
	<b>LIST OF TABLES</b>	<b>50</b>
	<b>INDEX</b>	<b>51</b>

### READ THIS FIRST

***These instructions are intended for qualified technical personnel. Prior commencing with any activities...***

- you must carefully read and understand this manual and
- you must follow the instructions given therein.

***EPOS4 positioning controllers are considered as partly completed machinery according to EU Directive 2006/42/EC, Article 2, Clause (g) and are intended to be incorporated into or assembled with other machinery or other partly completed machinery or equipment.***

***Therefore, you must not put the device into service,...***

- unless you have made completely sure that the other machinery fully complies with the EU directive's requirements!
- unless the other machinery fulfills all relevant health and safety aspects!
- unless all respective interfaces have been established and fulfill the herein stated requirements!

# 1 ABOUT THIS DOCUMENT

The present document provides you with information on the EPOS4 communication interfaces.

Find the latest edition of the present document as well as additional documentation and software for EPOS4 positioning controllers also on the Internet: →<http://epos.maxongroup.com>.

## 1.1 Intended Purpose

The purpose of the present document is to familiarize you with the described equipment and the tasks on safe and adequate installation and/or commissioning. Follow the described instructions ...

- to avoid dangerous situations,
- to keep installation and/or commissioning time at a minimum,
- to increase reliability and service life of the described equipment.

The present document is part of a documentation set and contains performance data and specifications, information on fulfilled standards, details on connections and pin assignment, and wiring examples. The below overview shows the documentation hierarchy and the interrelationship of its individual parts:

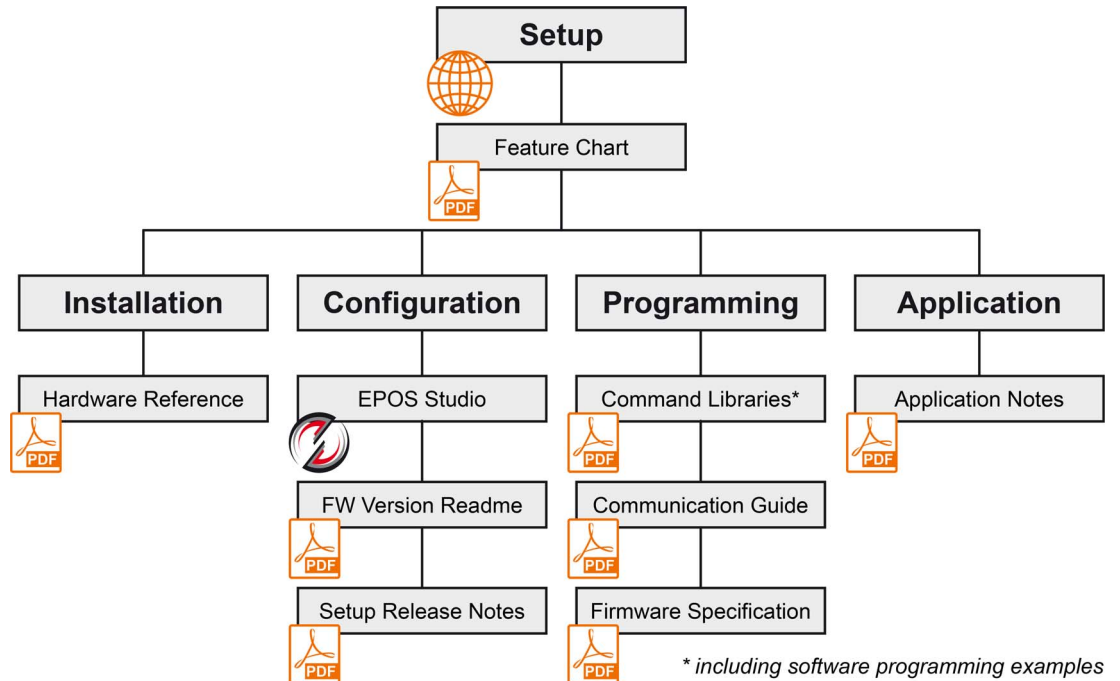

Figure 1-1 Documentation structure

## 1.2 Target Audience

The present document is intended for trained and skilled personnel. It conveys information on how to understand and fulfill the respective work and duties.

The present document is a reference book. It does require particular knowledge and expertise specific to the equipment described.

## 1.3 How to use

Take note of the following notations and codes which will be used throughout the document.

Notation	Explanation
EPOS4	stands for "EPOS4 Positioning Controller"
«Abcd»	indicates a title or a name (such as of document, product, mode, etc.)
(n)	refers to an item (such as part numbers, list items, etc.)
→	denotes "see", "see also", "take note of" or "go to"

Table 1-1 Notations used in this document

### 1.3.1 Trademarks and Brand Names

For easier legibility, registered brand names are listed below and will not be further tagged with their respective trademark. It must be understood that the brands (the below list is not necessarily concluding) are protected by copyright and/or other intellectual property rights even if their legal trademarks are omitted in the later course of this document.

Brand Name	Trademark Owner
Adobe® Reader®	© Adobe Systems Incorporated, USA-San Jose, CA
CANopen® CiA®	© CiA CAN in Automation e.V, DE-Nuremberg
EtherCAT®	© EtherCAT Technology Group, DE-Nuremberg, licensed by Beckhoff Automation GmbH, DE-Verl

Table 1-2 Brand names and trademark owners

## 1.4 Sources for additional Information

For further details and additional information, please refer to below listed sources:

Item	Reference
[1]	CAN in Automation's CAN Specification 2.0 <a href="http://www.can-cia.org">www.can-cia.org</a>
[2]	CiA 301 CANopen application layer and communication profile <a href="http://www.can-cia.org">www.can-cia.org</a>
[3]	CiA 305 CANopen Layer setting services (LSS) and protocols <a href="http://www.can-cia.org">www.can-cia.org</a>
[4]	CiA 306 CANopen Electronic device description <a href="http://www.can-cia.org">www.can-cia.org</a>
[5]	CiA 402 CANopen Drives and motion control device profile <a href="http://www.can-cia.org">www.can-cia.org</a>
[6]	ETG.1000 EtherCAT Specification <a href="http://www.ethercat.org">www.ethercat.org</a>
[7]	ETG.1020 EtherCAT Protocol Enhancements Specification <a href="http://www.ethercat.org">www.ethercat.org</a>
[8]	ETG.2000 EtherCAT Slave Information (ESI) Specification <a href="http://www.ethercat.org">www.ethercat.org</a>
[9]	IEC 61158-x-12: Industrial communication networks – Fieldbus specifications (CPF 12)
[10]	IEC 61800-7: Adjustable speed electrical power drives systems (Profile type 1)
[11]	EN 5325-4 Industrial communications subsystem based on ISO 11898 (CAN) for controller device interfaces Part 4: CANopen
[12]	USB Implementers Forum: Universal Serial Bus Revision 2.0 Specification: <a href="http://www.usb.org/developers/docs/usb20_docs/">www.usb.org/developers/docs/usb20_docs/</a>

Table 1-3 Sources for additional information

## 1.5 Copyright

This document is protected by copyright. Any further use (including reproduction, translation, microfilming, and other means of electronic data processing) without prior written approval is not permitted. The mentioned trademarks belong to their respective owners and are protected under intellectual property rights. © 2021 maxon. All rights reserved. Subject to change without prior notice.

CCMC | EPOS4 Communication Guide | Edition 2021-03 | DocID rel9707

maxon motor ag  
Brünigstrasse 220 +41 41 666 15 00  
CH-6072 Sachseln [www.maxongroup.com](http://www.maxongroup.com)

••page intentionally left blank••

## 2 USB & RS232 COMMUNICATION

### 2.1 EPOS4 USB & RS232 Command Reference

#### 2.1.1 Read Functions

##### 2.1.1.1 ReadObject

Read an object value from the Object Dictionary at the given Index and Subindex.

Request Frame		
OpCode	BYTE	0x60
Len	BYTE	2 (number of words)
Parameters	BYTE	Node-ID
	WORD	Index of Object
	BYTE	Subindex of Object

Response Frame		
OpCode	BYTE	0x00
Len	BYTE	4 (number of words)
Parameters	DWORD	→“Communication Error Code Definition” on page 6-47
	BYTE [4]	Data Bytes Read

##### 2.1.1.2 InitiateSegmentedRead

Start reading an object value from the Object Dictionary at the given Index and Subindex.

Request Frame		
OpCode	BYTE	0x81
Len	BYTE	2 (number of words)
Parameters	BYTE	Node-ID
	WORD	Index of Object
	BYTE	Subindex of Object

Response Frame		
OpCode	BYTE	0x00
Len	BYTE	5...132 (number of words)
Parameters	DWORD	→“Communication Error Code Definition” on page 6-47
	DWORD	Object Data Length (total number of bytes)
	BYTE	Length (max. 255 bytes)
	BYTE [0...254]	Data Bytes Read

### 2.1.1.3 SegmentRead

Read a data segment of the object initiated with the command → «InitiateSegmentedRead».

Request Frame				
<b>OpCode</b>	BYTE		0x62	
<b>Len</b>	BYTE		1 (number of words)	
<b>Parameters</b>	BYTE	[Bit 0] [Bit 1...7]	ControlByte	Toggle Bit Not used
	BYTE		Dummy Byte without meaning	

Response Frame				
<b>OpCode</b>	BYTE		0x00	
<b>Len</b>	BYTE		3...131 (number of words)	
<b>Parameters</b>	DWORD		→“Communication Error Code Definition” on page 6-47	
	BYTE		Length (max. 255 bytes)	
	BYTE	[Bit 0] [Bit 1] [Bit 2...7]	ControlByte	Toggle Bit Last Data Segment Not used
	BYTE [0...254]		Data Bytes Read	
	BYTE		Dummy Byte when length odd	



## 2.1.2 Write Functions

### 2.1.2.1 WriteObject

Write an object value to the Object Dictionary at the given Index and Subindex.

Request Frame		
<b>OpCode</b>	BYTE	0x68
<b>Len</b>	BYTE	4 (number of words)
<b>Parameters</b>	BYTE	Node-ID
	WORD	Index of Object
	BYTE	Subindex of Object
	BYTE [4]	Data Bytes to write

Response Frame		
<b>OpCode</b>	BYTE	0x00
<b>Len</b>	BYTE	2 (number of words)
<b>Parameters</b>	DWORD	→ "Communication Error Code Definition" on page 6-47

### 2.1.2.2 InitiateSegmentedWrite

Start writing an object value to the Object Dictionary at the given Index and Subindex. Use the command → «SegmentWrite» to write the data.

Note that gateway communication is not supported.

Request Frame		
<b>OpCode</b>	BYTE	0x69
<b>Len</b>	BYTE	4 (number of words)
<b>Parameters</b>	BYTE	Node-ID
	WORD	Index of Object
	BYTE	Subindex of Object
	DWORD	Object Data Length (total number of bytes)

Response Frame		
<b>OpCode</b>	BYTE	0x00
<b>Len</b>	BYTE	2 (number of words)
<b>Parameters</b>	DWORD	→ "Communication Error Code Definition" on page 6-47

### 2.1.2.3 SegmentWrite

Write a data segment to the object initiated with the command → «InitiateSegmentedWrite».

Note that gateway communication is not supported.

Request Frame				
<b>OpCode</b>	BYTE	0x6A		
<b>Len</b>	BYTE	1...129 (number of words)		
<b>Parameters</b>	BYTE	Length (max. 255 bytes)		
	BYTE	[Bit 0] [Bit 1] [Bit 2...7]	ControlByte	Toggle Bit Last Data Segment Not used
	BYTE [0...254]		Data Bytes to write	
	BYTE	Dummy Byte when length odd		

Response Frame				
<b>OpCode</b>	BYTE	0x00		
<b>Len</b>	BYTE	3 (number of words)		
<b>Parameters</b>	DWORD	→“Communication Error Code Definition” on page 6-47		
	BYTE	Length written (max. 255 bytes)		
	BYTE	[Bit 0] [Bit 1...7]	ControlByte	Toggle Bit Not used

### 2.1.2.4 SendNMTService

Send a NMT service. For example, change the NMT state or reset the device.

Request Frame				
<b>OpCode</b>	BYTE	0x70		
<b>Len</b>	BYTE	2		
<b>Parameters</b>	WORD	Node-ID		
	WORD	CmdSpecifier	1 2 128 129 130	Start Remote Node Stop Remote Node Enter Pre-Operational Reset Node Reset Communication

Response Frame				
<b>OpCode</b>	BYTE	0x00		
<b>Len</b>	BYTE	2 (number of words)		
<b>Parameters</b>	DWORD	→“Communication Error Code Definition” on page 6-47		

## 2.1.3 General CAN Commands

### 2.1.3.1 SendLSS

Send a LSS master message to the CAN bus.

Request Frame		
OpCode	BYTE	0x7A
Len	BYTE	4
Parameters	BYTE[8]	LSS master message

Response Frame		
OpCode	BYTE	0x00
Len	BYTE	2 (number of words)
Parameters	DWORD	→“Communication Error Code Definition” on page 6-47

### 2.1.3.2 ReadLSS

Read a LSS slave message from the CAN bus.

Note that a LSS slave message can be read only if a SendLSS command has been executed before.

Request Frame		
OpCode	BYTE	0x7B
Len	BYTE	2
Parameters	WORD	Timeout [ms]

Response Frame		
OpCode	BYTE	0x00
Len	BYTE	6 (number of words)
Parameters	DWORD	→“Communication Error Code Definition” on page 6-47
	BYTE[8]	LSS slave message frame data

## 2.2 Data Link Layer

### 2.2.1 Flow Control

The EPOS4 always communicates as a slave.

A frame is only sent as an answer to a request. All commands send an answer. The master must always initiate communication by sending a packet structure.

The data flow while transmitting and receiving frames are as follows:

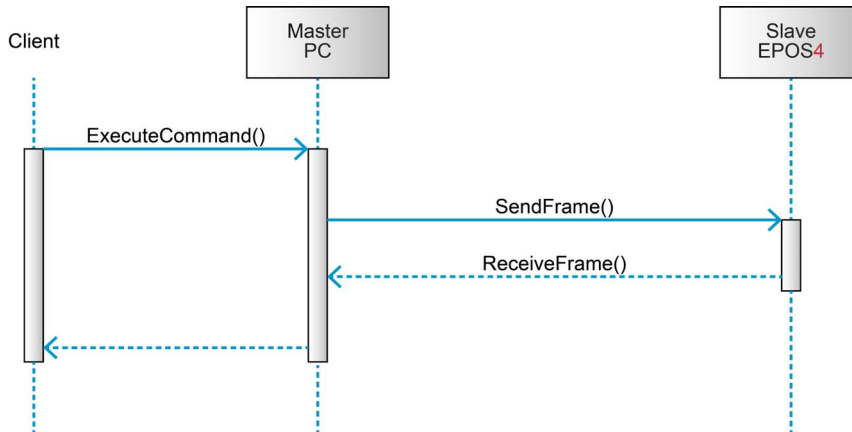

Figure 2-2 USB/RS232 communication – Commands

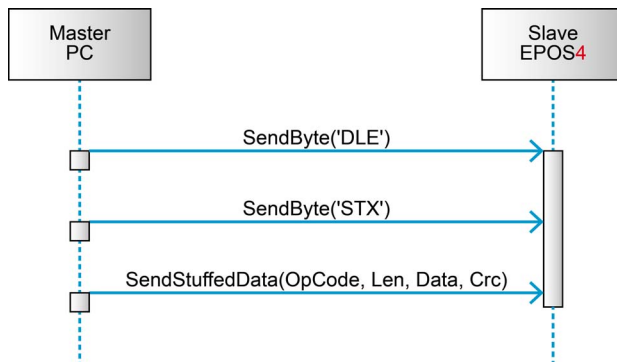

Figure 2-3 USB/RS232 communication – Sending a data frame to EPOS4

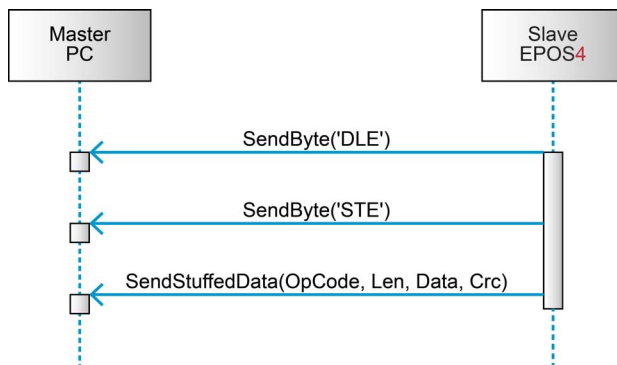

Figure 2-4 USB/RS232 communication – Receiving a response data frame from EPOS4

## 2.2.2 Frame Structure

The data bytes are sequentially transmitted in frames. A frame composes of...

- synchronization (and byte stuffing),
- header,
- variably long data field, and
- 16-bit long cyclic redundancy check (CRC) for verification of data integrity.

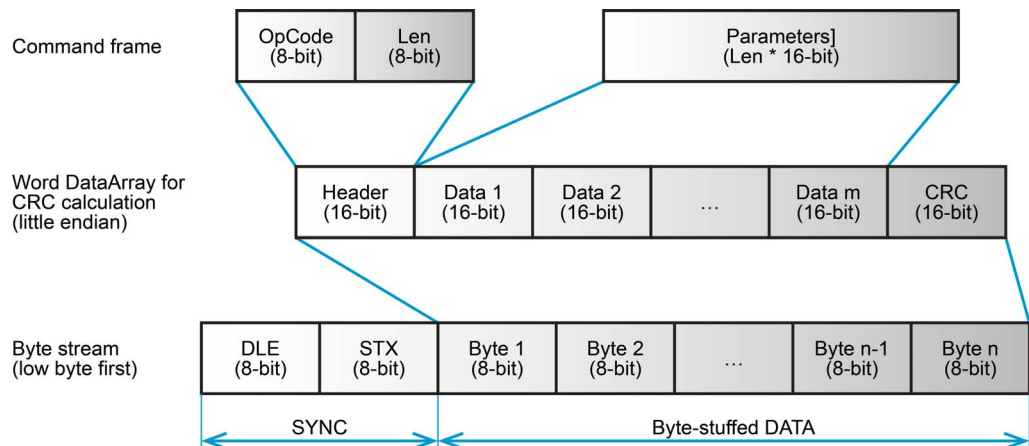

Figure 2-5 USB/RS232 communication – Frame structure

**SYNC** The first two bytes are used for frame synchronization.

**DLE** Starting frame character “DLE” (Data Link Escape) = 0x90

**STX** Starting frame character “STX” (Start of Text) = 0x02

**HEADER** The header consists of 2 bytes. The first field determines the type of data frame to be sent or received. The next field contains the length of the data fields.

**OpCode** Operation command to be sent to the slave. For details on the command set → “EPOS4 USB & RS232 Command Reference” on page 2-7.

**Len** Represents the number of words (16-bit value) in the data fields [0...143].

**DATA** The data fields contain the parameters of the message. The low byte of the word is transmitted first.

**Data[i]** The parameter word of the command. The low byte is transmitted first.

**CRC** 16-bit long cyclic redundancy check (CRC) for verification of data integrity.



**Note**

As a reaction to a bad OpCode or CRC value, the slave sends a frame containing the corresponding error code.

For an example on composition and structure of EPOS4 messages → chapter “2.2.9 Example: Command Instruction” on page 2-17.

### 2.2.3 Cyclic Redundancy Check (CRC)

CRC is used for verification of data integrity.

#### 2.2.3.1 CRC Calculation



##### Note

- The 16-bit CRC checksum uses the algorithm CRC-CCITT.
- For calculation, the 16-bit generator polynomial " $x^{16}+x^{12}+x^5+x^0$ " is used.
- The CRC is calculated before data stuffing and synchronization.
- Add a CRC value of "0" (zero) for CRC calculation.
- The data frame bytes must be calculated as a word.

#### 2.2.3.2 CRC Algorithm

ArrayLength: Len + 2	WORD dataArray[ArrayLength]
Generator Polynom G(x):	10001000000100001 (= $x^{16}+x^{12}+x^5+x^0$ )
DataArray[0]:	HighByte(Len) + LowByte(OpCode)
DataArray[1]:	Data[0]
DataArray[2]:	Data[1]
...	...
DataArray[ArrayLength-1]:	0x0000 (CrcValue)

```
WORD CalcFieldCRC(WORD* pDataArray, WORD ArrayLength)
{
    WORD shifter, c;
    WORD carry;
    WORD CRC = 0;

    //Calculate pDataArray Word by Word
    while(ArrayLength--)
    {
        shifter = 0x8000;           //Initialize BitX to Bit15
        c = *pDataArray++;         //Copy next DataWord to c
        do
        {
            carry = CRC & 0x8000;   //Check if Bit15 of CRC is set
            CRC <<= 1;               //CRC = CRC * 2
            if(c & shifter) CRC++;   //CRC = CRC + 1, if BitX is set in c
            if(carry) CRC ^= 0x1021; //CRC = CRC XOR G(x), if carry is true
            shifter >>= 1;           //Set BitX to next lower Bit, shifter = shifter/2
        } while(shifter);
    }
    return CRC
}
```

Figure 2-6 USB/RS232 communication – CRC algorithm

### 2.2.4 Byte Stuffing

The sequence “DLE” and “STX” are reserved for frame start synchronization. If the character “DLE” appears at a position between “OpCode” and “CRC” and is not a starting character, the byte must be doubled (byte stuffing). Otherwise, the protocol begins to synchronize for a new frame. The character “STX” needs not to be doubled.

**EXAMPLES:**

Sending Data	0x21, <b>0x90</b> , 0x45
Stuffed Data	0x21, <b>0x90, 0x90</b> , 0x45

Sending Data	0x21, <b>0x90, 0x02</b> , 0x45
Stuffed Data	0x21, <b>0x90, 0x90, 0x02</b> , 0x45

Sending Data	0x21, <b>0x90, 0x90</b> , 0x45
Stuffed Data	0x21, <b>0x90, 0x90, 0x90, 0x90</b> , 0x45



**Important:**

*Byte stuffing is used for all bytes (CRC included) in the frame except the starting characters.*

### 2.2.5 Transmission Byte Order

To send and receive a word (16-bit) via the serial port, the low byte will be transmitted first.

Multiple byte data (word = 2 bytes, long word = 4 bytes) are transmitted starting with the less significant byte (LSB) first.

A word will be transmitted in this order: byte0 (LSB), byte1 (MSB).

A long word will be transmitted in this order: byte0 (LSB), byte1, byte2, byte3 (MSB).

### 2.2.6 Data Format (RS232)

Data are transmitted in an asynchronous way, thus each data byte is transmitted individually with its own start and stop bit. The format is 1 start bit, 8 data bits, no parity, 1 stop bit. Most serial communication chips (SCI, UART) can generate such data format.

### 2.2.7 Timeout Handling

The timeout is handled over a complete frame. Hence, the timeout is evaluated over the sent data frame, the command processing procedure and the response data frame. For each frame (frames, data processing), the timer is reset and timeout handling will recommence.

Object	Index	Subindex	Default
RS232 Frame Timeout	0x2005	0x00	500 [ms]
USB Frame Timeout	0x2006	0x00	500 [ms]

Table 2-4 USB/RS232 communication – Timeout handling



**Note**

*To cover special requirements, the timeout may be changed by writing to the Object Dictionary!*

2.2.8 Slave State Machine

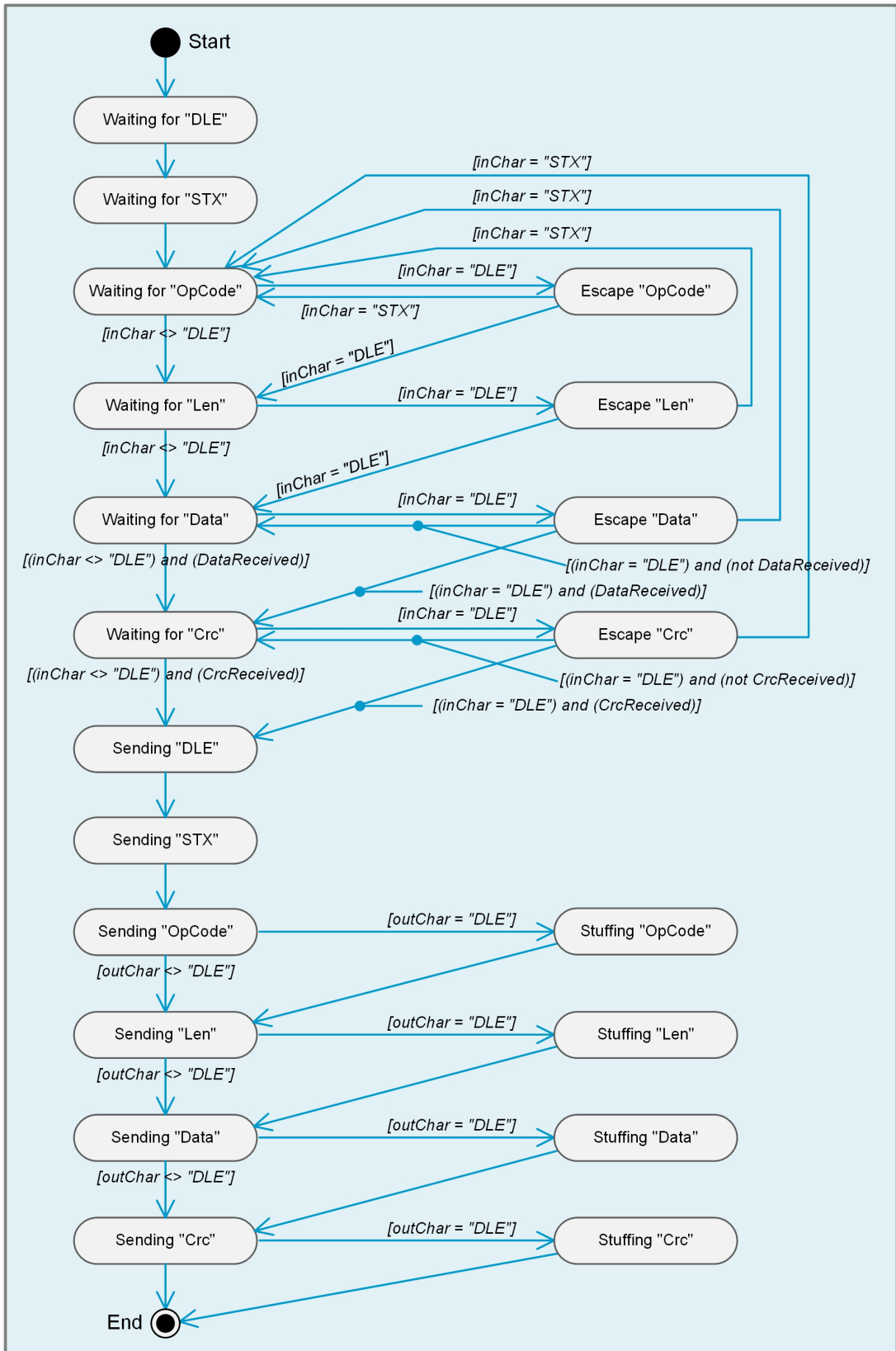

Figure 2-7 USB/RS232 communication – Slave State Machine



## 2.2.9 Example: Command Instruction

The following example demonstrated composition and structure of the EPOS4 messages during transmission and reception via USB or RS232.

The command sent to the EPOS4 is "ReadObject", it can be used to read an object with up to 4 bytes.

**ReadObject** "Home Position" (Index = 0x30B0, Subindex = 0x00) from Node-ID 1

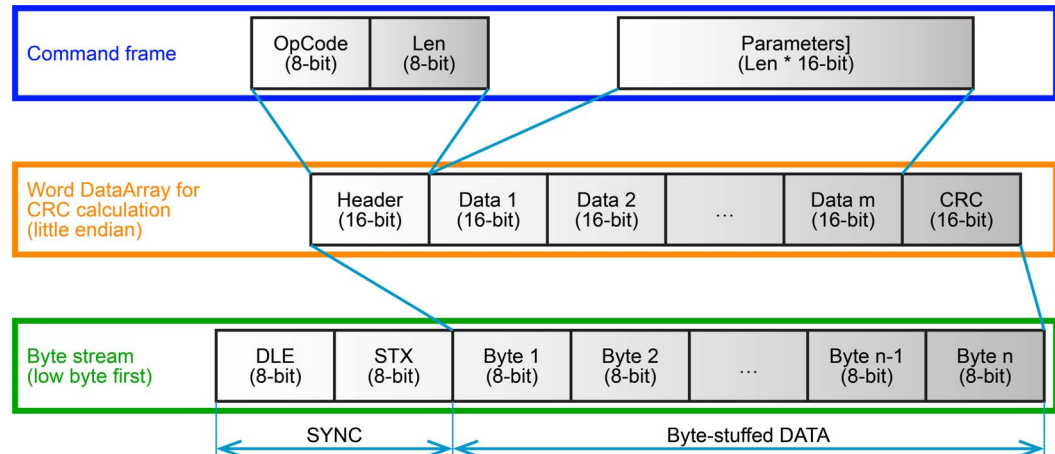

Figure 2-8 USB/RS232 communication – Command instruction (example)

### A) SETUP

- 1) Setup the desired frame (for details → chapter "2.1 EPOS4 USB & RS232 Command Reference" on page 2-7).

Request frame			
OpCode	BYTE	Read object	0x60
Len	BYTE	Number of words	0x02
Parameters	BYTE	Node-ID	0x01
	WORD	Index of object	0x30B0
	BYTE	Subindex of object	0x00

### B) CRC CALCULATION

For details → chapter "2.2.3 Cyclic Redundancy Check (CRC)" on page 2-14):

- 2) Prepare the word DataArray for CRC calculation (little endian):

DataArray	
DataArray[0]	0x0260
DataArray[1]	0xB001
DataArray[2]	0x0030
DataArray[3]	<b>0x0000</b> → use CRC value of "0" (zero)



#### Important:

- Make sure that the CRC is calculated correctly. If the CRC is not correct, the command will neither be accepted nor processed.
- CRC calculation includes all bytes of the data frame except synchronization bytes and byte stuffing.
- The data frame bytes must be calculated as a word.
- For calculation, use a CRC value of "0" (zero).

- 3) Calculate the CRC (use algorithm as to →chapter “2.2.3.2 CRC Algorithm” on page 2-14):  
 ArrayLength = Len + 2  
 CrcValue = CalcFieldCRC(&DataArray, ArrayLength)  
 DataArray[ArrayLength-1] = CrcValue
- 4) Add the CRC value to the DataArray:

DataArray	
DataArray[0]	0x0260
DataArray[1]	0xB001
DataArray[2]	0x0030
DataArray[3]	<b>0x622E</b> →the calculated CRC value

### C) COMPLETION

- 5) Pack the DataArray to a byte stream (low byte first).
- 6) Add sync bytes.
- 7) Add byte stuffing (→chapter “2.2.4 Byte Stuffing” on page 2-15).
- 8) Transmit the stuffed byte stream (→chapter “2.2.5 Transmission Byte Order” on page 2-15):  
 SendStuffedData(&DataArray)  
 Transmission order (low byte first):  
**0x90,0x02,0x60,0x02,0x01,0xB0,0x30,0x00,0x2E,0x62**

### D) WAIT FOR RECEIVE FRAME

- 9) The EPOS4 will answer to the command “ReadObject” with an answer frame and the returned parameters in the data block as follows:  
 Reception order (low byte first):  
**0x90,0x02,0x00,0x04,0x00,0x00,0x00,0x00,0x01,0x90,0x90,0x00,0x00,0x9A,0x5C**



#### Important:

- Do not send any data before the receive frame or a timeout is present.
- EPOS4 cannot process data simultaneously.

### E) REMOVE BYTE STUFFING AND THE SYNCHRONIZATION ELEMENTS

- 10) Byte stream without stuffing and synchronization elements:  
**0x00,0x04,0x00,0x00,0x00,0x00,0x01,0x90,0x00,0x00,0x9A,0x5C**

### F) CRC CHECK

For details →chapter “2.2.3 Cyclic Redundancy Check (CRC)” on page 2-14):

- 11) Prepare the word DataArray for CRC calculation (little endian):

DataArray	
DataArray[0]	0x0400
DataArray[1]	0x0000
DataArray[2]	0x0000
DataArray[3]	0x9001
DataArray[4]	0x0000
DataArray[5]	0x5C9A

- 12) Calculate the CRC (use algorithm as to →chapter “2.2.3.2 CRC Algorithm” on page 2-14). Thereby, valid value for CRC is “0” (zero):  
 ArrayLength= Len + 2  
 CrcValue = CalcFieldCRC(&DataArray, ArrayLength)  
 Valid = (0x0000 == CrcValue)

### G) CHECK

- 13) Check the EPOS4 receive frame.

Response frame			
OpCode	BYTE	Read object	0x00
Len	BYTE	Number of words	0x04
Parameters	BYTE	Node-ID	0x01
	DWORD	Communication error	0x00000000 →no error
	DWORD	Data bytes read	0x00009001 →36'865 inc



#### Important:

- If the error code is unequal to “0” (zero), the command was not processed!
- Check →chapter “6 Communication Error Code Definition” on page 6-47 for error details.
- Fix the error before attempting to resend the data frame.

## 2.3 Physical Layer

### 2.3.1 USB

#### **ELECTRICAL STANDARD**

The EPOS4's USB interface follows the «Universal Serial Bus Specification Revision 2.0». You may wish to download the file from the Internet (for URL →“Sources for additional Information” on page 1-5), full details are described in chapter “7.3 Physical Layer”.

### 2.3.2 RS232

#### **ELECTRICAL STANDARD**

The EPOS4's communication protocol uses the RS232 standard to transmit data over a 3-wire cable (signals TxD, RxD, and GND).

The RS232 standard can only be used for point-to-point communication between a master and a single EPOS4 slave. It uses negative, bipolar logic with a negative voltage signal representing a logic “1”, and positive voltage representing a logic “0”. Voltages of -3...-25 V with respect to signal ground (GND) are considered logic “1”, whereas voltages of +3...25 V are considered logic “0”.

#### **MEDIUM**

For the physical connection, a 3-wire cable will be required. We recommend to install a shielded and twisted pair cable in order to achieve good performance, even in an electrically noisy environment. Depending on the bit rate used, the cable length can range from 3...15 meters. However, we do not recommend to use RS232 cables longer than 5 meters.

### 3 CAN COMMUNICATION

#### 3.1 General Information

maxon EPOS4 drives' CAN interface follows the CiA CANopen specifications...

- CiA 301 V4.2: CANopen application layer and communication profile (→[2]) corresponds with the international standard EN 5325-4; Industrial communications subsystem based on ISO 11898 (CAN) (→[11])
- CiA 305 V3.0: CANopen Layer setting services (LSS) and protocols (→[3])
- CiA 306 V1.3: CANopen Electronic device description (→[4])
- CiA 402 V4.0: CANopen drives and motion control device profile (→[5]) corresponds with international standard IEC 61800-7 Ed 2.0; Generic interface and use of profiles for power drive systems – profile type 1(→[10])

##### 3.1.1 Documentation

For further information on CAN/CANopen as well as respective specifications listed references in →chapter “1.4 Sources for additional Information” on page 1-5.

##### 3.1.2 Notations, Abbreviations and Terms used

Notation	Description	Format
nnn <b>b</b>	Numbers followed by “b”.	binary
nnn <b>h</b>	Numbers followed by “h”.	hexadecimal
nnnn	All other numbers.	decimal

Table 3-5 CAN communication – Notations

Abbreviation	Description
<b>CAN</b>	CAN Application Layer
<b>CMS</b>	CAN Message Specification
<b>COB</b>	Communication Object (CAN Message) – a unit of transportation in a CAN message network. Data must be sent across a network inside a COB.
<b>COB-ID</b>	COB Identifier – identifies a COB uniquely in a network and determines the priority of that COB in the MAC sublayer
<b>EDS</b>	Electronic Data Sheet – used by CAN network configuration tools, e.g. PLC's system managers
<b>ID</b>	Identifier – the name by which a CAN device is addressed
<b>LSS</b>	Layer setting services
<b>MAC</b>	Medium Access Control – one of the sublayers of the Data Link Layer in the CAN Reference Model. Controls the medium permitted to send a message.
<b>OD</b>	Object Dictionary – the full set of objects supported by the node. Represents the interface between application and communication (→term “Object” on page 3-22).

Continued on next page.

Abbreviation	Description
PDO	Process Data Object – object for data exchange between several devices
PLC	Programmable Controller – can serve as a CAN Master for the EPOS4
RO	Read Only
RW	Read Write
SDO	Service Data Object – peer-to-peer communication with access to the device's Object Directory
WO	Write Only

Table 3-6 CAN communication – Abbreviations

Term	Description
CAN Client or CAN Master	A host (typically a PC, PLC, or other control device) supervising the nodes of a network
CAN Server or CAN Slave	A node in the CAN network that can provide service under the CAN Master's control
Object	A CAN message with meaningful functionality and/or data. Objects are referenced according to addresses in the Object Dictionary.
Receive	"received" data is being sent from the control equipment to the EPOS4
Transmit	"transmitted" data is being sent from the EPOS4 to the other equipment

Table 3-7 CAN communication – Terms

### 3.2 CANopen Basics

Subsequently described are the CANopen communication features most relevant to the maxon's EPOS4 positioning controllers. For more detailed information consult above mentioned CANopen documentation.

The CANopen communication concept can be described similar to the ISO Open Systems Interconnection (OSI) Reference Model. CANopen represents a standardized application layer and communication profile.

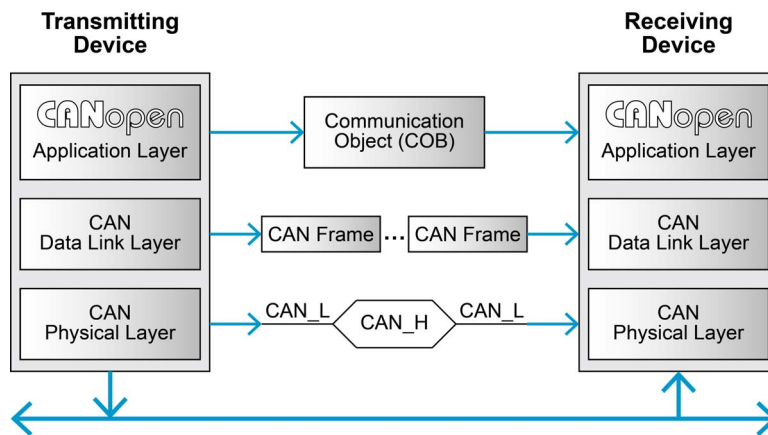

Figure 3-9 CAN communication – Protocol layer interactions

#### 3.2.1 Physical Layer

CANopen is a networking system based on the CAN serial bus. It assumes that the device's hardware features a CAN transceiver and a CAN controller as specified in ISO 11898. The physical medium is a differently driven 2-wire bus line with common return.

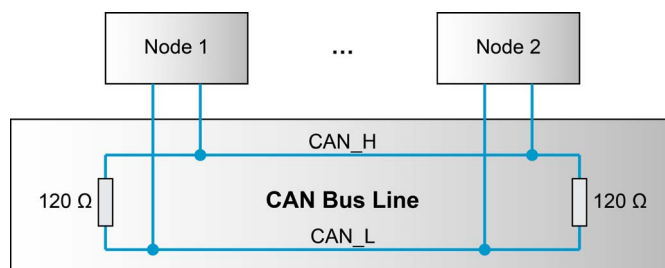

Figure 3-10 CAN communication – ISO 11898 basic network setup

### 3.2.2 Data Link Layer

The CAN data link layer is also standardized in ISO 11898. Its services are implemented in the Logical Link Control (LLC) and Medium Access Control (MAC) sublayers of a CAN controller.

- The LLC provides acceptance filtering, overload notification and recovery management.
- The MAC is responsible for data encapsulation (decapsulation), frame coding (stuffing/destuffing), medium access management, error detection, error signaling, acknowledgment, and serialization (deserialization).

A Data Frame is produced by a CAN node when the node intends to transmit data or if this is requested by another node. Within one frame, up to 8 byte data can be transported.

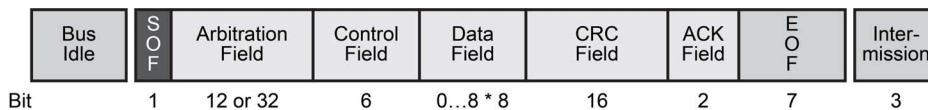

Figure 3-11 CAN communication – CAN data frame

- The Data Frame begins with a dominant Start of Frame (SOF) bit for hard synchronization of all nodes.
- The SOF bit is followed by the Arbitration Field reflecting content and priority of the message.
- The next field – the Control Field – specifies mainly the number of bytes of data contained in the message.
- The Cyclic Redundancy Check (CRC) field is used to detect possible transmission errors. It consists of a 15-bit CRC sequence completed by the recessive CRC delimiter bit.
- During the Acknowledgment (ACK) field, the transmitting node sends out a recessive bit. Any node that has received an error-free frame acknowledges the correct reception of the frame by returning a dominant bit.
- The recessive bits of the End of Frame (EOF) terminate the Data Frame. Between two frames, a recessive 3-bit Intermission field must be present.

With EPOS4, only the Standard Frame Format is supported.



Figure 3-12 CAN communication – Standard frame format

- The Identifier's (COB-ID) length in the Standard Format is 11 bit.
- The Identifier is followed by the RTR (Remote Transmission Request) bit. In Data Frames, the RTR bit must be dominant, within a Remote Frame, the RTR bit must be recessive.
- The Base ID is followed by the IDE (Identifier Extension) bit transmitted dominant in the Standard Format (within the Control Field).
- The Control Field in Standard Format includes the Data Length Code (DLC), the IDE bit, which is transmitted dominant and the reserved bit r0, also transmitted dominant.
- The reserved bits must be sent dominant, but receivers accept dominant and recessive bits in all combinations.



### 3.3 CANopen Application Layer

#### 3.3.1 Object Dictionary

The most significant part of a CANopen device is the Object Dictionary. It is essentially a grouping of objects accessible via the network in an ordered, predefined fashion. Each object within the dictionary is addressed using a 16-bit index and a 8-bit subindex. The overall layout of the standard Object Dictionary conforms to other industrial field bus concepts.

Index	Variable accessed
0x0000	Reserved
0x0001...0x025F	Data types (not supported on EPOS4)
0x0260...0x0FFF	Reserved
0x1000...0x1FFF	Communication Profile Area (CiA 301)
0x2000...0x5FFF	Manufacturer-specific Profile Area (maxon)
0x6000...0x9FFF	Standardized profile area 1st...8th logical device
0xA000...0xAFFF	Standardized network variable area (not supported on EPOS4)
0xB000...0xBFFF	Standardized system variable area (not supported on EPOS4)
0xC000...0xFFFF	Reserved (not supported on EPOS4)

Table 3-8 CAN communication – Object dictionary layout

A 16-bit index is used to address all entries within the Object Dictionary. In case of a simple variable, it references the value of this variable directly. In case of records and arrays however, the index addresses the entire data structure. The subindex permits individual elements of a data structure to be accessed via the network.

- For single Object Dictionary entries (such as UNSIGNED8, BOOLEAN, INTEGER32, etc.), the subindex value is always zero.
- For complex Object Dictionary entries (such as arrays or records with multiple data fields), the subindex references fields within a data structure pointed to by the main index.

An example: A receive PDO, the data structure at index 1400h defines the communication parameters for that module. This structure contains fields for the COB-ID and the transmission type. The subindex concept can be used to access these individual fields as shown below.

Index	Subindex	Variable accessed	Data Type
1400h	0	Number of entries	UNSIGNED8
1400h	1	COB-ID used by RxPDO 1	UNSIGNED32
1400h	2	Transmission type RxPDO 1	UNSIGNED8

Table 3-9 CAN communication – Object dictionary entry

### 3.3.2 Communication Objects

CANopen communication objects are described by the services and protocols. They are classified as follows:

- The real-time data transfer is performed by means of Process Data Objects.
- With Service Data Objects, read/write access to entries of a device Object Dictionary is provided.
- Special Function Objects provide application-specific network synchronization and emergency messages.
- Network Management Objects provide services for network initialization, error control and device status control.

Communication Objects	
Process Data Objects (PDO)	
Service Data Objects (SDO)	
Special Function Objects Synchronization Objects (SYNC)	Time Stamp Objects (not used on EPOS4)
	Emergency Objects (EMCY)
Network Management Objects	NMT Message
	Node Guarding Object

Table 3-10 CAN communication – Communication objects

### 3.3.3 Predefined Communication Objects

#### 3.3.3.1 PDO Object

PDO communication can be described by the producer/consumer model. Process data can be transmitted from one device (producer) to one another device (consumer) or to numerous other devices (broadcasting). PDOs are transmitted in a non-confirmed mode. The producer sends a Transmit PDO (TxPDO) with a specific identifier that corresponds to the identifier of the Receive PDO (RxPDO) of one or more consumers.

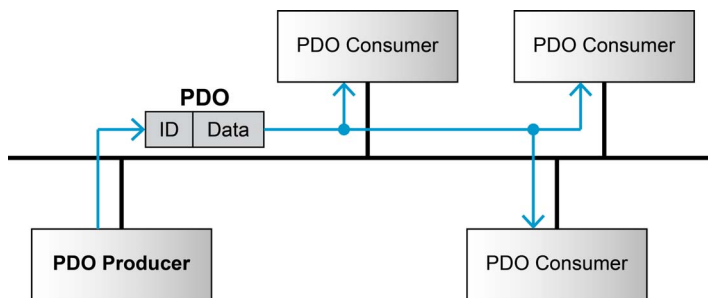

Figure 3-13 CAN communication – Process Data Object (PDO)

There are two PDO services:

- The Write PDO is mapped to a single CAN Data frame.
- The Read PDO is mapped to CAN Remote Frame, which will be responded by the corresponding CAN Data Frame.

Read PDOs are optional and depend on the device capability. The complete data field of up to 8 byte may contain process data. Number and length of a device's PDOs are application-specific and must be specified in the device profile.

The number of supported PDOs depends on the actually used CANopen device. Theoretically, up to 512 RxPDOs and 512 TxPDOs are possible in a CANopen network. Typically, most devices support 4 RxPDOs and 4 TxPDOs. The actual number of available PDOs is indicated by the CANopen device's object dictionary and described by its firmware specification (such as the separately available documents → «EPOS2 Firmware Specification» or → «EPOS4 Firmware Specification»).

The PDOs correspond to entries in the Object Dictionary and serve as an interface to objects linked to real time process data of the master's application code. The application objects' data type and their mapping into the master's PDOs must match with the slave's PDO mapping. The PDO data exchange parameters, PDO structure, and mapped objects are defined in the object entries of 0x1400, 0x1600 (for RxPDO 1), and 0x1800, 0x1A00 (for TxPDO 1).

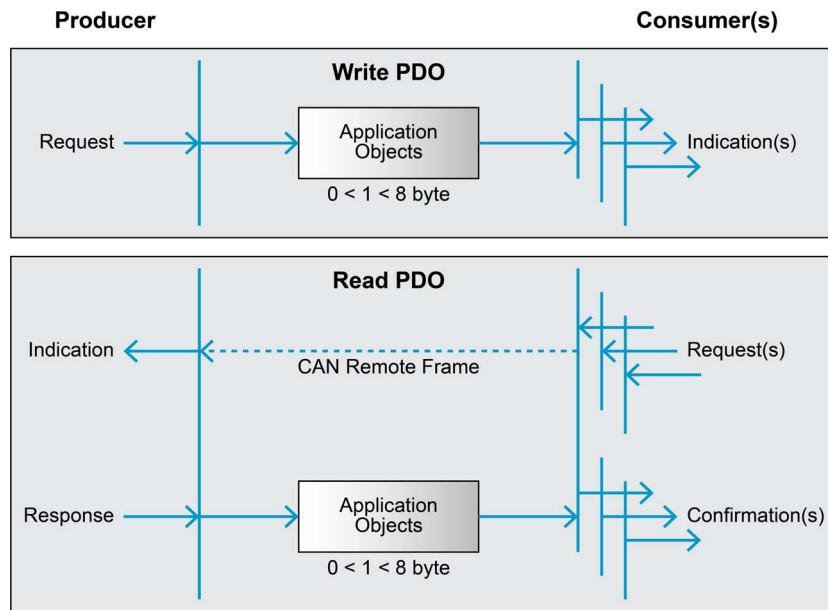

Figure 3-14 CAN communication – PDO protocol

The CANopen communication profile distinguishes three message triggering modes:

- a) Event-driven  
Message transmission is triggered by the occurrence of an object-specific event specified in the device profile.
- b) Polling by remote frames  
The transmission of asynchronous PDOs may be initiated upon receipt of a remote request initiated by another device.
- c) Synchronized  
Synchronous PDOs are triggered by the expiration of a specified transmission period synchronized by the reception of the SYNC object.

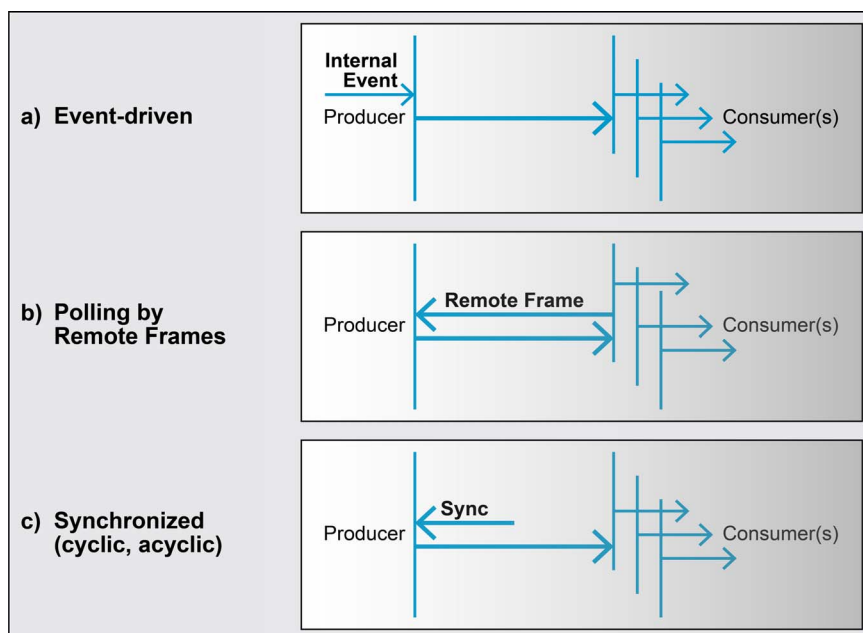

Figure 3-15 CAN communication – PDO communication modes

**3.3.3.2 SDO Object**

With Service Data Objects (SDOs), the access to entries of a device Object Dictionary is provided. A SDO is mapped to two CAN Data Frames with different identifiers, because communication is confirmed. By means of a SDO, a peer-to-peer communication channel between two devices may be established. The owner of the accessed Object Dictionary is the server of the SDO. A device may support more than one SDO, one supported SDO is mandatory and the default case.

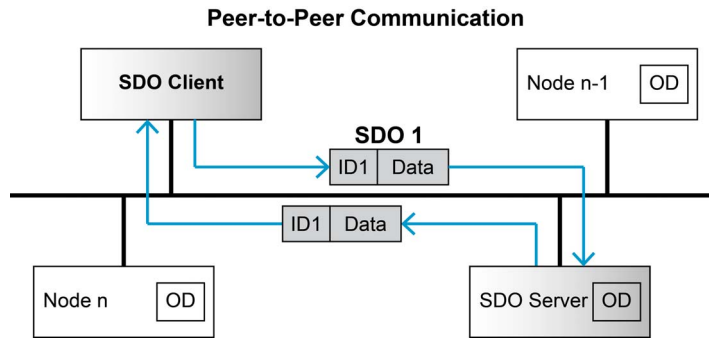

Figure 3-16 CAN communication – Service Data Object (SDO)

Read and write access to the CANopen Object Dictionary is performed by SDOs. The Client/Server Command Specifier contains the following information:

- download/upload
- request/response
- segmented/expedited transfer
- number of data bytes
- end indicator
- alternating toggle bit for each subsequent segment

SDOs are described by the communication parameter. The default Server SDO (S\_SDO) is defined in the entry "1200h". In a CANopen network, up to 256 SDO channels requiring two CAN identifiers each may be used.

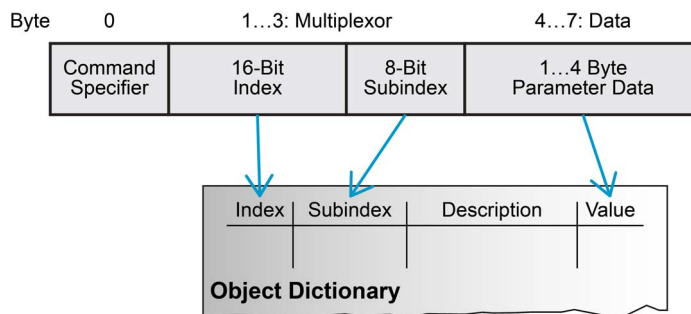

Figure 3-17 CAN communication – Object dictionary access

### 3.3.3.3 SYNC Object

The SYNC producer provides the synchronization signal for the SYNC consumer.

As the SYNC consumers receive the signal, they will commence carrying out their synchronous tasks. In general, fixing of the transmission time of synchronous PDO messages coupled with the periodicity of the SYNC Object's transmission guarantees that sensors may arrange sampling of process variables and that actuators may apply their actuation in a coordinated manner. The identifier of the SYNC Object is available at index "1005h".

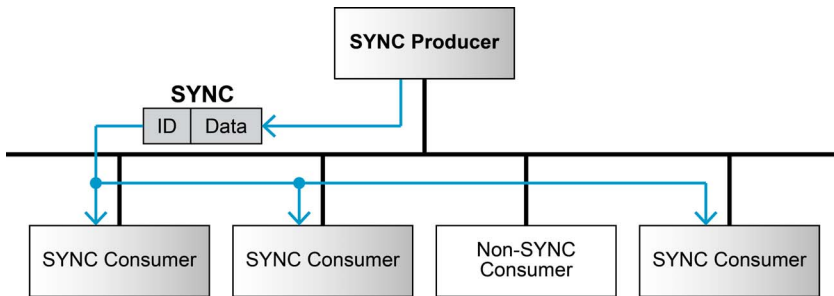

Figure 3-18 CAN communication – Synchronization object (SYNC)

Synchronous transmission of a PDO means that the transmission is fixed in time with respect to the transmission of the SYNC Object. The synchronous PDO is transmitted within a given time window "synchronous window length" with respect to the SYNC transmission and, at the most, once for every period of the SYNC. The time period between SYNC objects is specified by the parameter "communication cycle period".

CANopen distinguishes the following transmission modes:

- synchronous transmission
- asynchronous transmission

Synchronous PDOs are transmitted within the synchronous window after the SYNC object. The priority of synchronous PDOs is higher than the priority of asynchronous PDOs.

Asynchronous PDOs and SDOs can be transmitted at every time with respect to their priority. Hence, they may also be transmitted within the synchronous window.

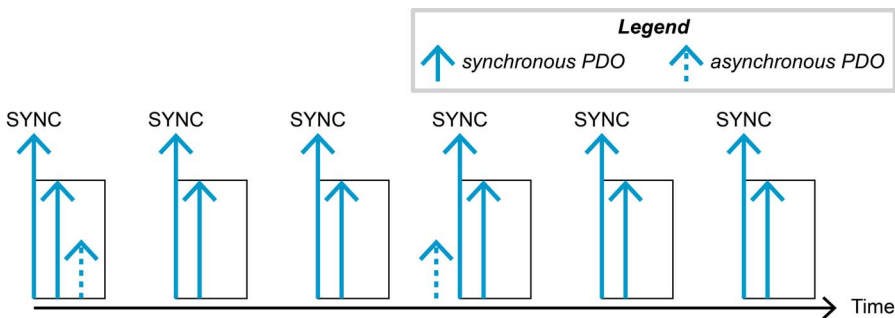

Figure 3-19 CAN communication – Synchronous PDO

### 3.3.3.4 EMCY Object

Emergency messages are triggered by the occurrence of a device internal fatal error. They are transmitted by the concerned device to the other devices with high priority, thus making them suitable for interrupt type error alerts.

An Emergency Telegram may be sent only once per “error event”, i.e. the emergency messages must not be repeated. No further emergency message shall be transmitted as long as no new errors occur on a CANopen device. The error register as well as additional, device-specific information are specified in the device profiles by means of emergency error codes defined as to CANopen Communication Profile.

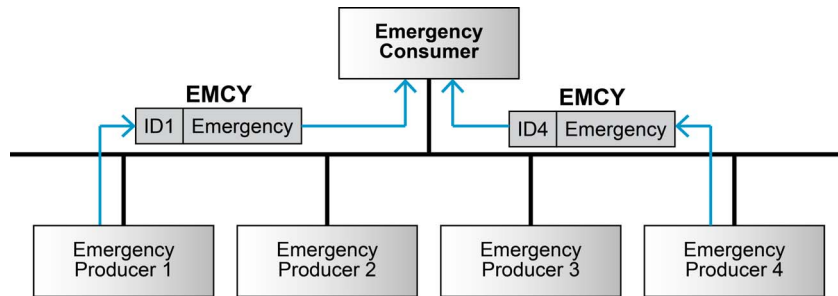

Figure 3-20 CAN communication – Emergency service (EMCY)

### 3.3.3.5 NMT Services

The CANopen network management is node-oriented and follows a master/slave structure. It requires one device in the network that fulfils the function of the NMT Master. The other nodes are NMT Slaves.

Network management provides the following functionality groups:

- Module Control Services for initialization of NMT Slaves that want to take part in the distributed application.
- Error Control Services for supervision of nodes' and network's communication status.
- Configuration Control Services for up/downloading of configuration data from/to a network module.

A NMT Slave represents that part of a node, which is responsible for the node's NMT functionality. It is uniquely identified by its module ID.

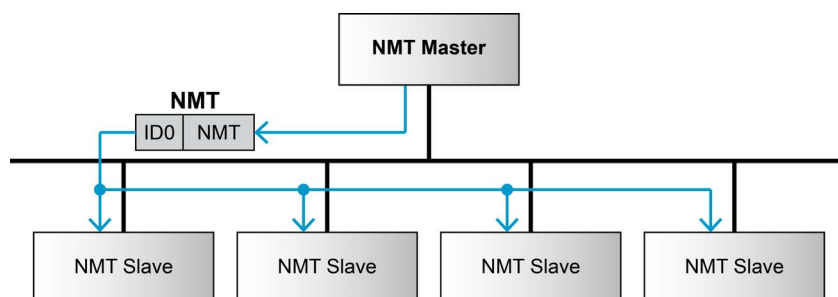

Figure 3-21 CAN communication – Network management (NMT)

The CANopen NMT Slave devices implement a state machine that automatically brings every device to «Pre-Operational» state, once powered and initialized.

In «Pre-Operational» state, the node may be configured and parameterized via SDO (e.g. using a configuration tool), PDO communication is not permitted. The NMT Master may switch from «Pre-Operational» to «Operational», and vice versa.

In «Operational» state, PDO transfer is permitted. By switching a device into «Stopped» state it will be forced to stop PDO and SDO communication. Furthermore, «Operational» can be used to achieve certain application behavior. The behavior's definition is part of the device profile's scope. In «Operational», all communication objects are active. Object Dictionary access via SDO is possible. However, implementation

aspects or the application state machine may require to switching off or to read only certain application objects while being operational (e.g. an object may contain the application program, which cannot be changed during execution).

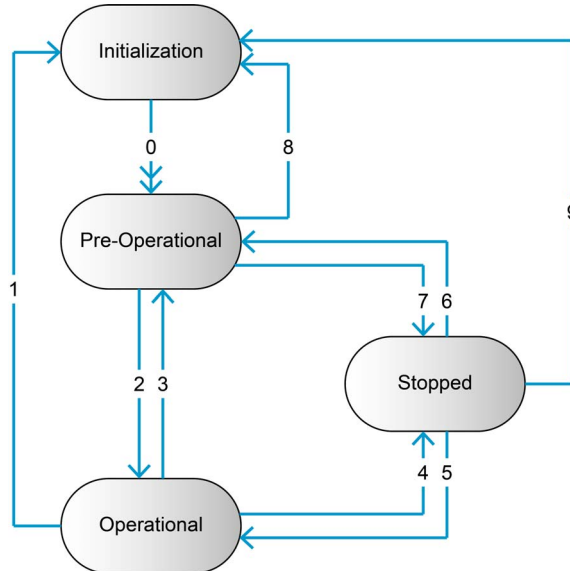

Figure 3-22 CAN communication – NMT slave states

CANopen Network Management provides the following services, which can be distinguished by the Command Specifier (CS).

Service [a]	Transition	NMT State after Command	Remote [c]	Functionality
– [b]	0	Pre-Operational	FALSE	Communication:
Enter Pre-Operational	3, 6	Pre-Operational	FALSE	<ul style="list-style-type: none"> <li>• Service Data Objects (SDO) Protocol</li> <li>• Emergency Objects</li> <li>• Network Management (NMT) Protocol</li> </ul>
Reset Communication	1, 8, 9	Initialization (Pre-Operational)	FALSE	Calculates SDO COB-IDs. Setup Dynamic PDO-Mapping and calculates PDO COB-IDs. Communication: <ul style="list-style-type: none"> <li>• While initialization is active, Layer setting services (LSS) communication is active. If no valid Node ID is configured, the device stays in initialization until a valid Node ID is set.</li> <li>• Upon completion, a boot-up message will be sent to the CAN Bus.</li> </ul>
Reset Node	1, 8, 9	Initialization (Pre-Operational)	FALSE	Generates a general reset of the EPOS4 software having the same effect as turning off and on the supply voltage. Not saved parameters will be overwritten with the values that have been saved in the device's persistent memory (e.g. Flash, EEPROM) by processing the «Store parameters» function of object 0x1010 before.
Start Remote Node	2, 5	Operational	TRUE	Communication: <ul style="list-style-type: none"> <li>• Service Data Objects (SDO) Protocol</li> <li>• Process Data Objects (PDO) Protocol</li> <li>• Emergency Objects</li> <li>• Network Management (NMT) Protocol</li> </ul>

Continued on next page.



Service [a]	Transition	NMT State after Command	Remote [c]	Functionality
Stop Remote Node	4, 7	Stopped	FALSE	Communication: <ul style="list-style-type: none"> <li>• Network Management (NMT) Protocol</li> <li>• Layer setting services (LSS)</li> <li>• Lifeguarding (Heartbeating)</li> </ul>
[a] The command may be sent with Network Management (NMT) protocol.				
[b] The EPOS4 automatically generates the transition after initialization is completed. A Boot-Up message is being sent.				
[c] Remote flag Bit 9 of the Statusword.				

Table 3-11 CAN communication – NMT slave (commands, transitions, and states)

The communication object possesses the identifier (=0) and consists of two bytes. The Node-ID defines the destination of the message. If zero, the protocol addresses all NMT Slaves.

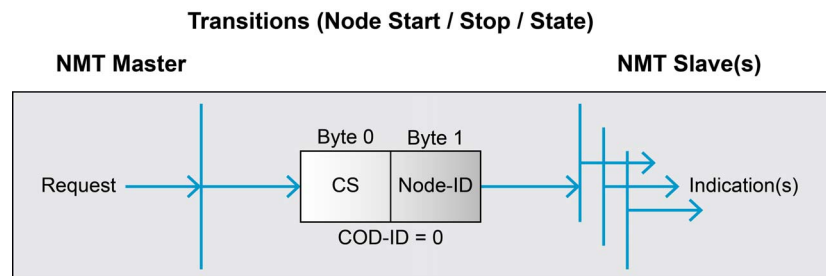

Figure 3-23 CAN communication – NMT object

Protocol	COB-ID	CS (Byte 0)	Node-ID (Byte 1)	Functionality
<b>Enter Pre-Operational</b>	0	0x80	0 (all)	All CANopen nodes (EPOS4 devices) will enter NMT State «Pre-Operational».
	0	0x80	n	The CANopen node (EPOS4 device) with Node-ID “n” will enter NMT State «Pre-Operational».
<b>Reset Communication</b>	0	0x82	0 (all)	All CANopen nodes (EPOS4 devices) will reset the communication.
	0	0x82	n	The CANopen node (EPOS4 device) with Node-ID “n” will reset the communication.
<b>Reset Node</b>	0	0x81	0 (all)	All CANopen nodes (EPOS4 devices) will reset.
	0	0x81	n	The CANopen node (EPOS4 device) with Node-ID “n” will reset.
<b>Start Remote Node</b>	0	0x01	0 (all)	All CANopen nodes (EPOS4 devices) will enter NMT State «Operational».
	0	0x01	n	The CANopen node (EPOS4 device) with Node-ID “n” will enter NMT State «Operational».
<b>Stop Remote Node</b>	0	0x02	0 (all)	All CANopen nodes (EPOS4 devices) will enter NMT State «Stopped».
	0	0x02	n	The CANopen node (EPOS4 device) with Node-ID “n” will enter NMT State «Stopped».

Table 3-12 CAN communication – NMT protocols

### 3.4 Identifier Allocation Scheme

The default ID allocation scheme consists of a functional part (Function Code) and a Module ID, which allows distinguishing between devices. The Module ID is assigned by DIP switches and a SDO Object.

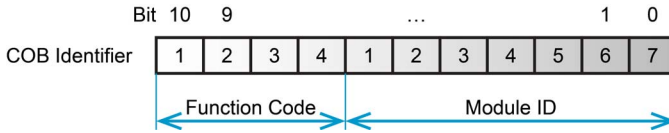

Figure 3-24 CAN communication – Default identifier allocation scheme

This ID allocation scheme allows peer-to-peer communication between a single master device and up to 127 slave devices. It also supports broadcasting of non-confirmed NMT Services, SYNC and Node Guarding.

The predefined master/slave connection set supports...

- one emergency object,
- one SDO,
- four Receive PDOs and three Transmit PDOs and the
- node guarding object.

Object	Function Code (binary)	Resulting COB-ID		Communication Parameter at Index
NMT	0000	0		–
SYNC	0001	128	(0080h)	1005h
EMERGENCY		129...255	(0081h-00FFh)	1014h
PDO1 (tx)	0011	385...511	(0181h-01FFh)	1800h
PDO1 (rx)	0100	513...639	(0201h-027Fh)	1400h
PDO2 (tx)	0101	641...8767	(0281h-02FFh)	1801h
PDO2 (rx)	0110	769...895	(0301h-037Fh)	1401h
PDO3 (tx)	0111	897...1023	(0381h-03FFh)	1802h
PDO3 (rx)	1000	1025...1151	(0401h-047Fh)	1402h
PDO4 (tx)	1001	1153...1279	(0481h-04FFh)	1803h
PDO4 (rx)	1010	1281...1407	(0501h-057Fh)	1403h
SDO1 (tx)	1011	1409...1535	(0581h-05FFh)	1200h
SDO1 (rx)	1100	1537...1663	(0601h-067Fh)	1200h

Table 3-13 CAN communication – Objects of the default connection set

## 3.5 Layer Setting Services (LSS)

By using layer setting services and protocols, a LSS Slave may be configured via CAN network without using DIP switches for setting the Node-ID and bit timing parameters.

The CANopen device that can configure other devices via CANopen network is called «LSS Master». There must be only one (active) LSS Master in a network. The CANopen device that will be configured by the LSS Master via CANopen network is called «LSS Slave».

An LSS Slave can be identified by its worldwide (at least network-wide) unique LSS address. The LSS address consists of the sub objects «Vendor ID», «Product code», «Revision number», and «Serial number» of the CANopen «Identity object» 0x1018 (→EPOS4 Firmware Specification). In the network, there must not be other LSS Slaves possessing the same LSS address.

With this unique LSS address an individual CANopen device can be allocated within the network. The Node-ID is valid if it is in the range of 0x01...0x7F, value 0xFF identifies not configured CANopen devices.

Communication between LSS Master and LSS Slaves is accomplished by LSS protocols which use only two COB-IDs:

- LSS master message from LSS Master to LSS Slaves (COB-ID 0x7E5)
- LSS slave message from the LSS Slaves to LSS Master (COB-ID 0x7E4).

Layer Setting Services are only accessible in NMT slave state «Stopped». To enter Stopped state, «Stop remote node» (→“NMT Services” on page 3-31) is used.

### 3.5.1 Overview

The table below represents an overview on the LSS commands including details on whether they may be used in states «Waiting» and «Configuration». To change the LSS state, the LSS commands →Switch State Global or →Switch State Selective may be used.

Command Specifier	LSS Command	LSS State Waiting	LSS State Configuration
0x04	→Switch State Global	yes	yes
0x40...0x43	→Switch State Selective	yes	no
0x11	→Configure «Node-ID»	no	yes
0x13	→Configure Bit Timing Parameters	no	yes
0x15	→Activate Bit Timing Parameters	no	yes
0x17	→Store Configuration Protocol	no	yes
0x5A	→Inquire Identity «Vendor ID»	no	yes
0x5B	→Inquire Identity «Product code»	no	yes
0x5C	→Inquire Identity «Revision number»	no	yes
0x5D	→Inquire Identity «Serial number»	no	yes
0x5E	→Inquire Identity «Node-ID»	no	yes
0x46...0x4B	→Identify Remote Slave	yes	yes
0x4C	→Identify non-configured Remote Slave	yes	yes

Table 3-14 LSS commands – Overview

### 3.5.2 LSS Commands

#### 3.5.2.1 Switch State Global

Changes the state of all connected LSS Slaves to «Configuration» or back to «Waiting». Thereby, particular LSS commands are not permitted (→Table 3-14).

cs	0x04	LSS command specifier 4 or switch state global
mode	0	switch to LSS state waiting
	1	switch to LSS state configuration



Figure 3-25 LSS – Switch state global

#### 3.5.2.2 Switch State Selective

Changes the state of one LSS Slave from «Waiting» to «Configuration».

The following LSS command specifiers are used:

- 0x40 to submit the «Vendor ID»
- 0x41 to submit the «Product code»
- 0x42 to submit the «Revision number»
- 0x43 to submit the «Serial number» («Identity object» 0x1018; →EPOS4 Firmware Specification)

Then, the single addressed LSS Slave changes to configuration state and answers by sending a command specifier 0x44 response.

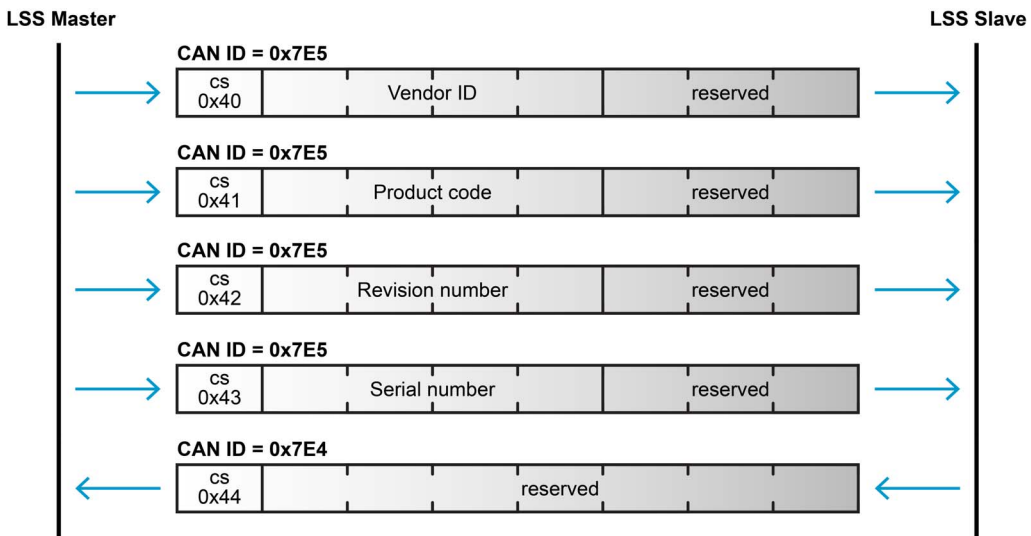

Figure 3-26 LSS – Switch state selective

### 3.5.2.3 Configure «Node-ID»

Configures the Node-ID (of value 1...127).

The LSS Master must determine the LSS Slave's Node-ID in LSS configuration state. The LSS Master is responsible to switch a single (**only one!**) LSS Slave into LSS state «Configuration» (→Switch State Selective) before requesting this service.

cs	0x11	LSS Slave answers with error code and specific error
error code	0	protocol successfully completed
	1	Node-ID out of value range
specific error	always 0	

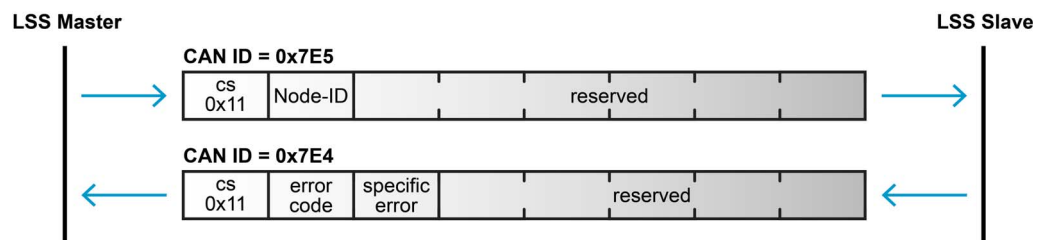

Figure 3-27 LSS – Configure «Node-ID»

### 3.5.2.4 Configure Bit Timing Parameters

By means of the service configure bit timing parameters, the LSS Master must configure new bit timing. The new bit timing will be active not before receiving →Store Configuration Protocol or →Activate Bit Timing Parameters.

table selector	always 0	
table index	CAN bit rate codes	
error code	0	protocol successfully completed
	1	bit timing not supported
specific error	always 0	



Figure 3-28 LSS – Configure bit timing parameters

### 3.5.2.5 Activate Bit Timing Parameters

Activates the bit timing parameters selected with →Configure Bit Timing Parameters.

switch delay	The duration [ms] of the two periods time to wait until the bit timing parameters switch is done (first period) and before transmitting any CAN message with the new bit timing parameters after performing the switch (second period).
--------------	---

Upon receiving an activate bit timing command, the LSS Slave stops communication on old (actual) bit rate. After the first switch delay, communication is switched to new bit rate, after a second switch delay, the LSS Slave is permitted to communicate with new bit rate.

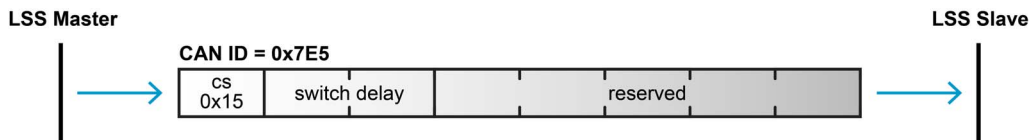

Figure 3-29 LSS – Activate bit timing parameters

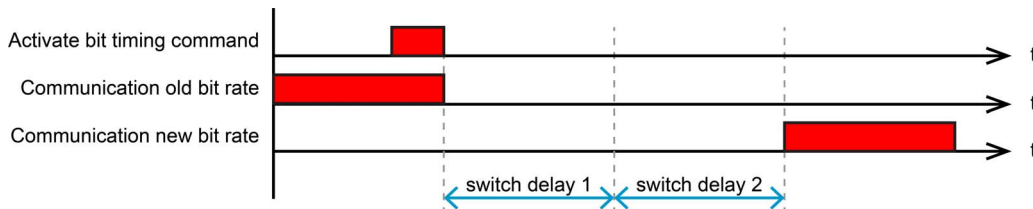

Figure 3-30 LSS – Switch delay

### 3.5.2.6 Store Configuration Protocol

Stores the parameters «Node-ID», «CAN bit rate», and «RS232 bit rate» in a non-volatile memory.

error code	0	protocol successfully completed
	1	store configuration is not supported
	2	storage media access error
specific error	always 0	

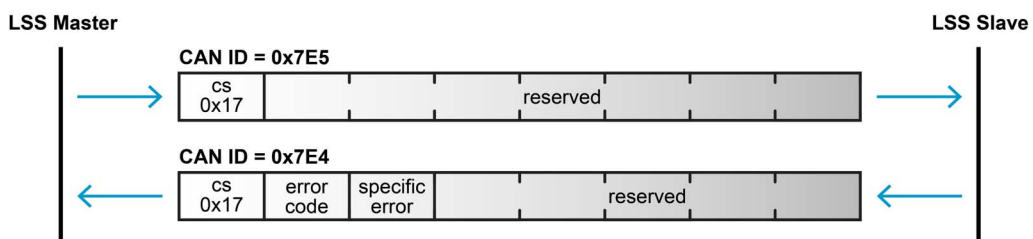

Figure 3-31 LSS – Store configuration protocol

### 3.5.2.7 Inquire Identity «Vendor ID»

Reads the «Vendor ID» of a LSS Slave («Identity object» 0x1018; →EPOS4 Firmware Specification).

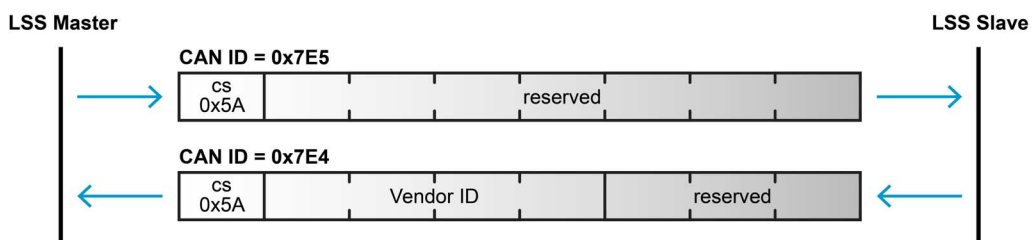

Figure 3-32 LSS – Inquire identity «Vendor ID»

**3.5.2.8 Inquire Identity «Product code»**

Reads the «Product code» of a LSS Slave («Identity object» 0x1018; →EPOS4 Firmware Specification).

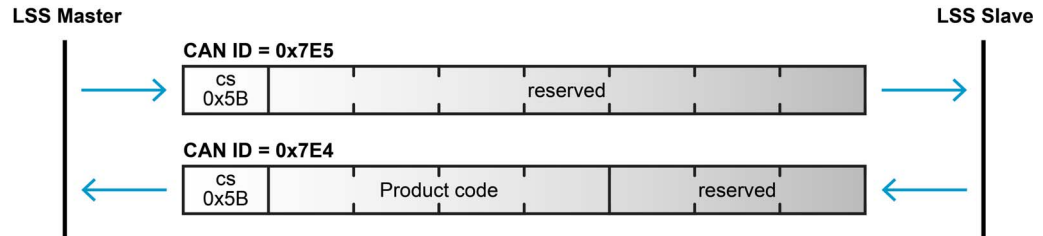

Figure 3-33 LSS – Inquire identity «Product code»

**3.5.2.9 Inquire Identity «Revision number»**

Reads the «Revision number» of a LSS Slave («Identity object» 0x1018; →EPOS4 Firmware Specification).

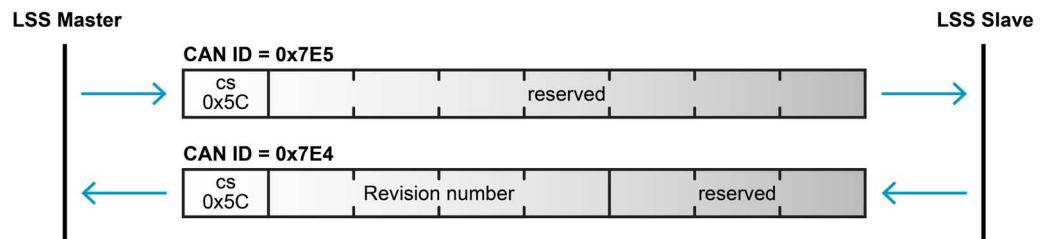

Figure 3-34 LSS – Inquire identity «Revision number»

**3.5.2.10 Inquire Identity «Serial number»**

Reads the «Serial number» of a LSS Slave («Identity object» 0x1018; →EPOS4 Firmware Specification).

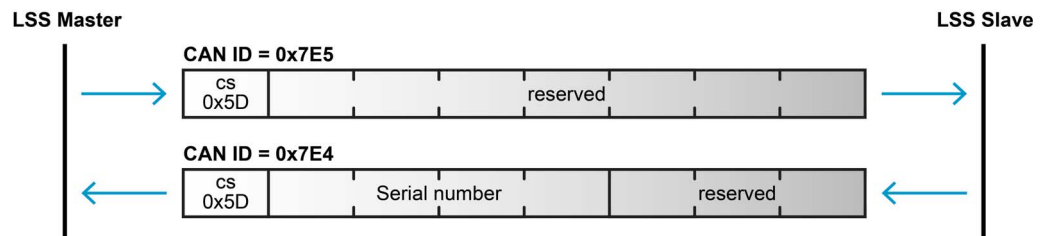

Figure 3-35 LSS – Inquire identity «Serial number»

**3.5.2.11 Inquire Identity «Node-ID»**

Reads the «Node-ID» of a LSS Slave («Identity object» 0x1018; →EPOS4 Firmware Specification).

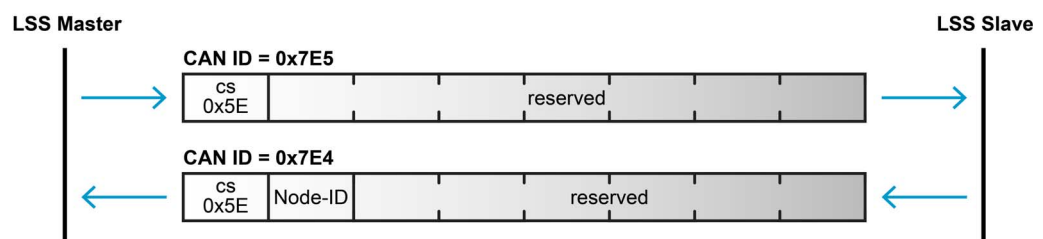

Figure 3-36 LSS – Inquire identity «Node-ID»

### 3.5.2.12 Identify Remote Slave

Detects the LSS Slaves in the CAN network. Thereby, the LSS Master sends an identify remote slave request with a single «Vendor ID», a single «Product code», and a span of «Revision numbers» and «Serial numbers» determined by a low and a high number to the LSS Slaves. All LSS Slaves which meet this LSS address range (inclusive boundaries) answer by a identify slave response (cs = 0x4F).

Along with this protocol, a binary network search can be implemented for the LSS Master. This method sets the LSS address range to the full address area first, then requests the identify remote slave. The range (which comprises one or more responded LSS Slaves) will be split in two sub-areas. The request to the sub-areas will be repeated until each LSS Slave has been identified («Identity object» 0x1018; →EPOS4 Firmware Specification).

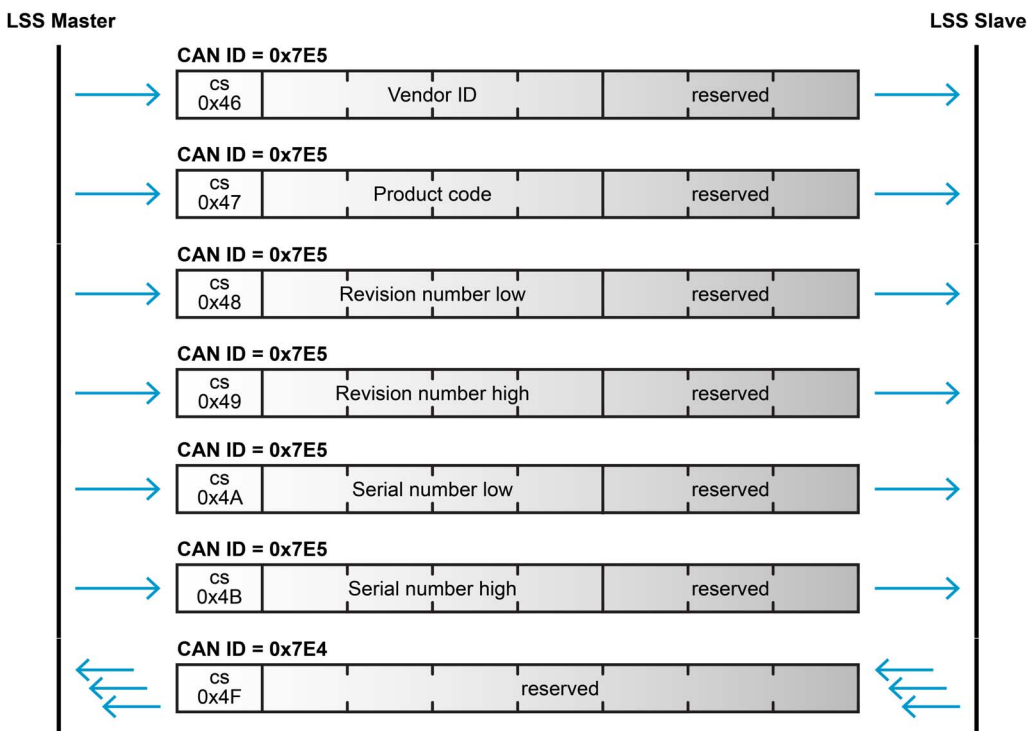

Figure 3-37 LSS – Identify remote slave

### 3.5.2.13 Identify non-configured Remote Slave

Allows the LSS Master to detect the presence of any non-configured device in the network. All LSS Slaves without a configured Node-ID (0xFF) will answer with a command specifier 0x50 response.

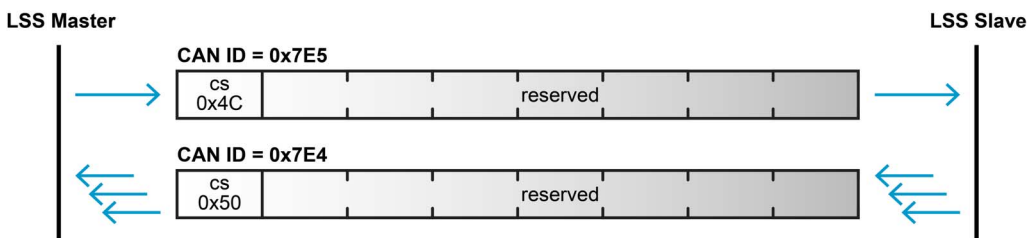

Figure 3-38 LSS – Identify non-configured remote slave



## 4 ETHERCAT COMMUNICATION

The functionality of the EPOS4 can be extended with an EtherCAT communication by using an EtherCAT Card in extension slot 1 or a Connector Board with EtherCAT functionality.

- ETG.1000 V1.0.4: EtherCAT Specification (→[6]) corresponds with the international standard IEC 61158-x-12 Industrial communication networks – Fieldbus specifications (CPF 12: EtherCAT) (→[9])
- ETG.1020 V1.2.0: EtherCAT Protocol Enhancements Specification (→[7])
- ETG.2000 V1.0.9: EtherCAT Slave Information (ESI) Specification (→[8])
- CiA 402 V4.0: CANopen Drives and motion control device profile (→[5]) corresponds with international standard IEC 61800-7 Ed 2.0; Generic interface and use of profiles for power drive systems – profile type 1 (→[10])



### Reference

You may access all relevant data and the free-for-download documentation from the EtherCAT website at →<http://ethercat.org/>. Navigate to the downloads section and search for the document “EtherCAT Technology Introduction”.

The document “EtherCAT\_Introduction\_xxxx.pdf” will serve well as an introduction to EtherCAT and does include information on the technology, implementation, and possible applications.

For EPOS4 firmware and hardware, consult maxon's comprehensive documentation set available at →<http://epos.maxongroup.com>. Among others, you will find the following documents:

### EPOS4 FIRMWARE SPECIFICATION

- Operating modes
- Communication and error handling
- Object dictionary
- etc.

### EPOS4 HARDWARE REFERENCE

- Technical data
- Wiring diagrams and connection overview
- etc

### EPOS4 APPLICATION NOTES

- EtherCAT integration
- etc

## 4.1 Communication Specifications

Topic	Description
Physical layer	IEEE 802.3 100 Base T (100 Mbit/s, full duplex)
Fieldbus connection	X14 (RJ45): EtherCAT Signal IN X15 (RJ45): EtherCAT Signal OUT
SyncManager	SM0: Mailbox output SM1: Mailbox input SM2: Process data outputs SM3: Process data inputs
FMMU	FMMU0: Mapped to process data output (RxPDO) area FMMU1: Mapped to process data input (TxPDO) area FMMU2: Mapped to mailbox status
Process data	Variable PDO mapping
Mailbox (CoE)	SDO Request, SDO Response, SDO Complete Access
Synchronization	SM-synchron, DC-synchron
LED indicators	NET status (green LED / red LED) NET port activity (green LED)

Table 4-15 EtherCAT communication – Communication specifications

## 4.2 EtherCAT State Machine (ESM)

The EtherCAT State Machine coordinates both Master and Slave during startup and operation. Their interaction (Master → Slave) results in changes of states being related to writes to the Application Layer Controlword: AL Ctrl (0x0120).

Upon initialization of Data Layer and Application Layer, the ESM enters “Init” state which defines the Application Layer’s root of the communication relationship between Master and Slave. In the Application Layer, no direct communication between Master and Slave is possible. The Master uses “Init” state...

- to initialize a configuration register set and
- to configure the Sync Manager.

Operation of the connected EPOS4 (the Slave) requires its prior initialization by the Master via the ESM. Within the ESM, transitions between certain states must follow a given scheme and will be initiated by the Master. The Slave itself must not execute any transition.

For an overview of the EtherCAT State Machine → Figure 4-39, for further descriptions → as from Table 4-16.

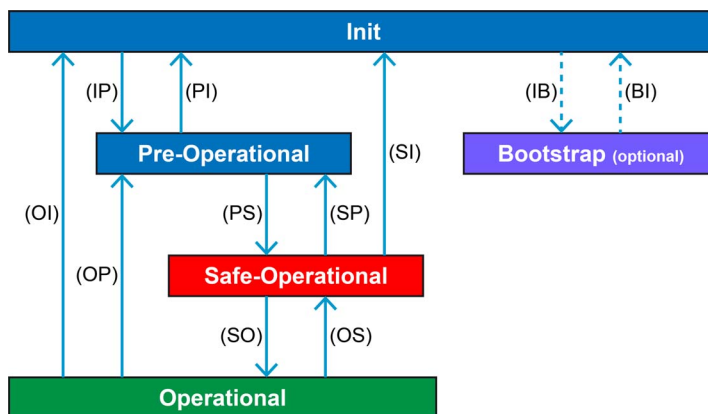

Figure 4-39 EtherCAT communication – ESM scheme

Condition	Description
Power ON	<ul style="list-style-type: none"> <li>EPOS4 is ON</li> <li>EPOS4 autonomously initializes and switches to state "Init"</li> </ul>
Init	<ul style="list-style-type: none"> <li>Master will synchronize the EtherCAT field bus</li> <li>Asynchronous communication between Master and Slave (Mailbox) will be established. At this time, no direct communication (Master to/from Slave) will yet take place.</li> <li>When all devices have been connected to the field bus and have successfully passed configuration, state will be changed to "Pre-Operational"</li> </ul>
Pre-Operational	<ul style="list-style-type: none"> <li>Asynchronous communication between Master and Slave (Mailbox) will be active.</li> <li>Master will setup cyclic communication via PDOs and necessary parameterization via acyclic communication.</li> <li>Upon successful completion, the Master will change to state "Safe-Operational".</li> </ul>
Safe-Operational	<ul style="list-style-type: none"> <li>Used to establish a safe operation condition of all devices connected to the EtherCAT field bus. Thereby, the Slave sends actual values to the Master while ignoring new setpoint values of the Master and using save default values instead.</li> <li>Upon successful completion, the Master will change to state "Operational"</li> </ul>
Operational	<ul style="list-style-type: none"> <li>Acyclic as well as cyclic communication is active</li> <li>Master and Slave exchange setpoint and actual values</li> <li>EPOS4 be enabled and operated via the CoE protocol</li> </ul>
Bootstrap	<ul style="list-style-type: none"> <li>Only FoE is possible (Mailbox)</li> <li>Firmware download via FoE</li> </ul>

Table 4-16 EtherCAT communication – ESM conditions

Transition	Status
IP	Start of acyclic communication (Mailbox)
PI	Stop of acyclic communication (Mailbox)
PS	Start of cyclic communication (Process Data) Slave sends actual values to Master Slave ignores setpoint values by the Master and uses default values
SP	Stop of cyclic communication (Process Data) Slave ceases to send actual values to the Master
SO	Slave evaluates actual setpoint values of the Master
OS	Slave ignores setpoint values from Master and uses internal default values
OP	Stop of cyclic communication (Process Data) Slave ceases to send actual values to the Master Master ceases to send actual values to the Slave
SI	Stop of cyclic communication (Process Data) Stop of acyclic communication (Mailbox) Slave ceases to send actual values to the Master Master ceases to send actual values to the Slave
OI	Stop of cyclic communication (Process Data) Stop of acyclic communication (Mailbox) Slave ceases to send actual values to the Master Master ceases to send actual values to the Slave
IB	Start Bootstrap Mode Firmware download via FoE (Mailbox)
BI	Reset device after successful firmware download

Table 4-17 EtherCAT communication – ESM transitions

Parameter	Address	Bit	Description
Control	0x0120	3...0	0x01: Init Request 0x02: Pre-Operational Request 0x03: Bootstrap Mode Request 0x04: Safe-Operational Request 0x08: Operational Request
Error Acknowledge	0x0120	4	0x00: No error acknowledgment 0x01: Error acknowledgment at rising edge
Reserved	0x0120	7...5	—
Application-specific	0x0120	15...8	—

Table 4-18 EtherCAT communication – ESM control register

### 4.3 Integration of ESI Files

SDOs are used to access the object dictionary. The corresponding interface is CoE. The EPOS4 is described with an XML file bearing the so-called ESI (EtherCAT Slave Information).

For in-detail description and examples on integration into the EtherCAT master environment see separate document → «EPOS4 Application Notes», chapter “EtherCAT Integration”.

### 4.4 Error Code Definition

For in detail information on error codes, device-specific errors, and error handling methodology see separate document → «EPOS4 Firmware Specification», chapter “Error Handling”.

## 5 GATEWAY COMMUNICATION (USB OR RS232 TO CAN)

Using the gateway functionality, the master can access all other EPOS4, EPOS2, or EPOS devices connected to the CAN Bus via the gateway device's USB port or RS232 interface. Even other CANopen devices (I/O modules) supporting the CANopen standard CiA 301 may be accessed.

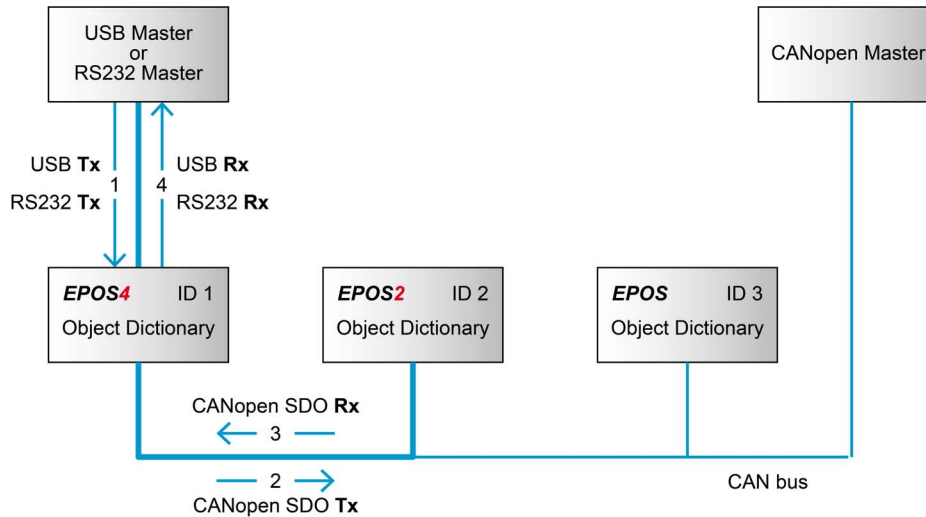

Figure 5-40 Gateway communication – Structure

Communication data are exchanged between USB/RS232 master and the gateway using a maxon-specific USB/RS232 protocol.

Data between the gateway and the addressed device are exchanged using the CANopen SDO protocol according to the CiA 301.

Step	Protocol	Sender → Receiver	Description
1	USB [maxon-specific] or RS232 [maxon-specific]	USB or RS232 Master ↓ EPOS4 ID 1, Gateway	Command including the Node-ID is sent to the device working as a gateway. The gateway decides whether to execute the command or to translate and forward it to the CAN Bus.  <b>Criteria:</b> Node-ID = 0 (Gateway) → Execute Node-ID = DIP switch → Execute else other Node-ID → Forward to CAN
2	CANopen [SDO]	EPOS4 ID 1, Gateway ↓ EPOS2 ID 2	The gateway is forwarding the command to the CAN network. The USB/RS232 command is translated to a CANopen SDO service.
3	CANopen [SDO]	EPOS2 ID 2 ↓ EPOS4 ID 1, Gateway	The EPOS4 ID 2 is executing the command and sending the corresponding CAN frame back to the gateway.
4	USB [maxon-specific] or RS232 [maxon-specific]	EPOS4 ID 1, Gateway ↓ USB or RS232 Master	The gateway is receiving the CAN frame corresponding to the SDO service. This CAN frame is translated back to the USB/RS232 frame and sent back to the USB/RS232 master.

Table 5-19 Gateway communication – Data exchange

**••page intentionally left blank••**

## 6 COMMUNICATION ERROR CODE DEFINITION

The following abort codes (= errors) are defined by CANopen Communication Profile CiA 301 and in use by the EPOS4. Codes greater than 0x0F00 0000 are manufacturer-specific (maxon specific).

Abort code	Name	Cause
0x0000 0000	No abort	Communication successful
0x0503 0000	Toggle error	Toggle bit not alternated
0x0504 0000	SDO timeout	SDO protocol timed out
0x0504 0001	Command unknown	Command specifier unknown
0x0504 0004	CRC error	CRC check failed
0x0601 0000	Access error	Unsupported access to an object
0x0601 0001	Write only error	Read command to a write only object
0x0601 0002	Read only error	Write command to a read only object
0x0601 0003	Subindex cannot be written	Subindex cannot be written, subindex 0 must be "0" (zero) for write access
0x0601 0004	SDO complete access not supported	The object can not be accessed via complete access
0x0602 0000	Object does not exist error	Last read or write command had wrong object index or subindex
0x0604 0041	PDO mapping error	Object is not mappable to the PDO
0x0604 0042	PDO length error	Number and length of objects to be mapped would exceed PDO length
0x0604 0043	General parameter error	General parameter incompatibility
0x0604 0047	General internal incompatibility error	General internal incompatibility in device
0x0606 0000	Hardware error	Access failed due to hardware error
0x0607 0010	Service parameter error	Data type does not match, length or service parameter do not match
0x0607 0013	Service parameter too short error	Data type does not match, length of service parameter too low
0x0609 0011	Subindex error	Last read or write command had wrong object subindex
0x0609 0030	Value range error	Value range of parameter exceeded
0x0800 0000	General error	General error
0x0800 0020	Transfer or store error	Data cannot be transferred or stored
0x0800 0022	Wrong device state error	Data cannot be transferred or stored to application because of present device state

Continued on next page.

Abort code	Name	Cause
0x0F00 FFBE	Password error	Password is incorrect
0x0F00 FFBF	Illegal command error	Command code is illegal (does not exist)
0x0F00 FFC0	Wrong NMT state error	Device is in wrong NMT state

Table 6-20 Communication errors



## LIST OF FIGURES

Figure 1-1	Documentation structure . . . . .	3
Figure 2-2	USB/RS232 communication – Commands . . . . .	12
Figure 2-3	USB/RS232 communication – Sending a data frame to EPOS4 . . . . .	12
Figure 2-4	USB/RS232 communication – Receiving a response data frame from EPOS4 . . . . .	12
Figure 2-5	USB/RS232 communication – Frame structure . . . . .	13
Figure 2-6	USB/RS232 communication – CRC algorithm . . . . .	14
Figure 2-7	USB/RS232 communication – Slave State Machine. . . . .	16
Figure 2-8	USB/RS232 communication – Command instruction (example). . . . .	17
Figure 3-9	CAN communication – Protocol layer interactions . . . . .	23
Figure 3-10	CAN communication – ISO 11898 basic network setup . . . . .	23
Figure 3-11	CAN communication – CAN data frame . . . . .	24
Figure 3-12	CAN communication – Standard frame format . . . . .	24
Figure 3-13	CAN communication – Process Data Object (PDO) . . . . .	26
Figure 3-14	CAN communication – PDO protocol . . . . .	27
Figure 3-15	CAN communication – PDO communication modes. . . . .	28
Figure 3-16	CAN communication – Service Data Object (SDO) . . . . .	29
Figure 3-17	CAN communication – Object dictionary access. . . . .	29
Figure 3-18	CAN communication – Synchronization object (SYNC) . . . . .	30
Figure 3-19	CAN communication – Synchronous PDO . . . . .	30
Figure 3-20	CAN communication – Emergency service (EMCY). . . . .	31
Figure 3-21	CAN communication – Network management (NMT). . . . .	31
Figure 3-22	CAN communication – NMT slave states . . . . .	32
Figure 3-23	CAN communication – NMT object. . . . .	33
Figure 3-24	CAN communication – Default identifier allocation scheme . . . . .	34
Figure 3-25	LSS – Switch state global . . . . .	36
Figure 3-26	LSS – Switch state selective. . . . .	36
Figure 3-27	LSS – Configure «Node-ID» . . . . .	37
Figure 3-28	LSS – Configure bit timing parameters . . . . .	37
Figure 3-29	LSS – Activate bit timing parameters . . . . .	38
Figure 3-30	LSS – Switch delay . . . . .	38
Figure 3-31	LSS – Store configuration protocol . . . . .	38
Figure 3-32	LSS – Inquire identity «Vendor ID». . . . .	38
Figure 3-33	LSS – Inquire identity «Product code» . . . . .	39
Figure 3-34	LSS – Inquire identity «Revision number» . . . . .	39
Figure 3-35	LSS – Inquire identity «Serial number». . . . .	39
Figure 3-36	LSS – Inquire identity «Node-ID» . . . . .	39
Figure 3-37	LSS – Identify remote slave . . . . .	40
Figure 3-38	LSS – Identify non-configured remote slave . . . . .	40
Figure 4-39	EtherCAT communication – ESM scheme . . . . .	42
Figure 5-40	Gateway communication – Structure . . . . .	45

## LIST OF TABLES

Table 1-1	Notations used in this document . . . . .	4
Table 1-2	Brand names and trademark owners . . . . .	4
Table 1-3	Sources for additional information . . . . .	5
Table 2-4	USB/RS232 communication – Timeout handling . . . . .	15
Table 3-5	CAN communication – Notations . . . . .	21
Table 3-6	CAN communication – Abbreviations . . . . .	22
Table 3-7	CAN communication – Terms. . . . .	22
Table 3-8	CAN communication – Object dictionary layout . . . . .	25
Table 3-9	CAN communication – Object dictionary entry . . . . .	25
Table 3-10	CAN communication – Communication objects . . . . .	26
Table 3-11	CAN communication – NMT slave (commands, transitions, and states) . . . . .	33
Table 3-12	CAN communication – NMT protocols . . . . .	33
Table 3-13	CAN communication – Objects of the default connection set. . . . .	34
Table 3-14	LSS commands – Overview . . . . .	35
Table 4-15	EtherCAT communication – Communication specifications . . . . .	42
Table 4-16	EtherCAT communication – ESM conditions . . . . .	43
Table 4-17	EtherCAT communication – ESM transitions . . . . .	43
Table 4-18	EtherCAT communication – ESM control register . . . . .	44
Table 5-19	Gateway communication – Data exchange . . . . .	45
Table 6-20	Communication errors . . . . .	48

## INDEX

### A

Access error (abort code) 47  
access to CAN bus via USB or RS232 45

### C

CAN  
communication 21  
error codes 47  
gateway 45  
CAN Client, Master, Server, Slave (definition) 22  
CMS (definition) 21  
COB, COB-ID (definition) 21  
codes (used in this document) 4  
Command unknown (abort code) 47  
communication via gateway 45  
CRC error (abort code) 47

### E

EDS (definition) 21  
error codes 47  
ESI file 44  
ESM (EtherCAT State Machine) 42

### F

functions  
read 7  
write 9

### G

General error (abort code) 47  
General internal incompatibility error (abort code) 47  
General parameter error (abort code) 47

### H

Hardware error (abort code) 47

### I

ID (definition) 21  
Illegal command error (abort code) 48  
InitiateSegmentedRead (function) 7  
InitiateSegmentedWrite (function) 9

### L

LSS (definition) 21

### M

MAC (definition) 21

### N

No abort (abort code) 47  
notations (used in this document) 4

### O

Object (definition) 22  
Object does not exist error (abort code) 47  
OD (definition) 21  
OSI Reference Model 23

### P

Password error (abort code) 48  
PDO (definition) 22  
PDO length error (abort code) 47  
PDO mapping error (abort code) 47  
PLC (definition) 22  
purpose of this document 3

### R

Read only error (abort code) 47  
ReadLSS (function) 11  
ReadObject (function) 7  
Receive (definition) 22  
RO, RW, WO (definition) 22  
RS232  
communication 7  
data format 15  
gateway 45  
physical layer 20

### S

SDO (definition) 22  
SDO complete access not supported (abort code) 47  
SDO timeout (abort code) 47  
SegmentedWrite (function) 10  
SegmentRead (function) 8  
SendLSS(function) 11  
Service parameter error (abort code) 47  
Service parameter too short error (abort code) 47  
Subindex cannot be written (abort code) 47  
Subindex error (abort code) 47

### T

Toggle error (abort code) 47  
Transfer or store error (abort code) 47  
Transmit (definition) 22

## **U**

### USB

- communication 7
- gateway 45
- physical layer 20

## **V**

Value range error (abort code) 47

## **W**

Write only error (abort code) 47

WriteObject (function) 9

Wrong device state error (abort code) 47

Wrong NMT state error (abort code) 48

••page intentionally left blank••



EtherCAT® is a registered trademark and patented technology, licensed by Beckhoff Automation GmbH, Germany

This document is protected by copyright. Any further use (including reproduction, translation, microfilming, and other means of electronic data processing) without prior written approval is not permitted. The mentioned trademarks belong to their respective owners and are protected under intellectual property rights.

© 2021 maxon. All rights reserved. Subject to change without prior notice.

CCMC | EPOS4 Communication Guide | Edition 2021-03 | DocID rel9707

maxon motor ag  
Brünigstrasse 220  
CH-6072 Sachseln

+41 41 666 15 00  
[www.maxongroup.com](http://www.maxongroup.com)